



# Stairclimber Owner's Manual

Intenza Escalate 550Ce2

Intenza Escalate 550Ci

Intenza Escalate 550C **PLUS X AWARD 2016**

Designed to inspire. © Intenza 2019. All rights reserved.

intenza

## Welcome To Intenza

---

### Thank you for purchasing our Intenza 550 Series Stairclimber .

Since Intenza Fitness first launched its line in 2012, Our compelling designs, innovation and energy efficiency have garnered multiple awards. Designed to inspire, your future is bright. Exciting. And, full of promise. It is our pleasure to join you on your fitness journey.

Before installing, or using, the Intenza 550 Series Stairclimber, please read all the instructions carefully to ensure that you have the required knowledge to safely and properly operate all the equipment's features.

The following will provide guidelines for quick set up and the correct way to use the equipment. We hope you can achieve the product experience that you expect.

Intenza 550 Series Stairclimber has been tested and designed to comply with the regulations for Class A digital device and for class S, studio use. This equipment has been tested and found to comply with the regulations for Class A digital device and for Class S studio use, pursuant to part 15 of the FCC rules and UL regulations. This equipment is in compliance with European Directives, i.e. Low Voltage Directive 2006/95/EC. Intenza 550 Series Stairclimber is designed to provide you with safe, intuitive, comfortable, reliable experience, guiding you to a healthy lifestyle.

#### **FCC Warning** Possible Radio / Television Interference

**NOTE** This equipment has been tested and found to comply with the limits for a Class A digital device, pursuant to part 15 of the FCC rules. These limits are designed to provide reasonable protection against harmful interference when the equipment is operated in a commercial environment. This equipment generate, uses and can radiate radio frequency energy, and if not installed and used in accordance with the instruction manual, may cause harmful interference to radio communications. Operation of this equipment in a residential area is likely to cause harmful interference in which case the user will be required to correct the interference at his own expense.

**CAUTION** Any changes or modifications to this equipment will affect the product warranty.

Team Intenza



Intenza 550 Series Stairclimber, **PLUS X AWARD 2016**

# Table of Contents

---

<b>1</b>	<b>IMPORTANT SAFETY INSTRUCTIONS AND PRECAUTIONS</b>	<b>4</b>
<b>2</b>	<b>INTENZA 550 SERIES STAIRCLIMBER OVERVIEW AND ASSEMBLY</b>	<b>6</b>
2.1	550Ce2 Overview	8
2.2	550Ci Overview	9
2.3	550Ce2 & 550Ci Part List	10
2.4	550Ce2 & 550Ci Assembly Instructions	11
<b>3</b>	<b>SETUP</b>	<b>14</b>
3.1	Electrical Power Requirements	14
3.2	Safety Space	15
3.3	How to Stabilize the Intenza 550 Series Stairclimber	16
3.4	Power Switch	16
<b>4</b>	<b>HOW TO USE INTENZA 550 SERIES STAIRCLIMBER</b>	<b>17</b>
4.1	550Ce2 Entertainment Console Overview	18
4.2	550Ce2 Entertainment And Media Operation	20
4.2.1	550Ce2 Entertainment And Media Operation: TV	21
4.2.2	550Ce2 Entertainment And Media Operation: Intenzacast	22
4.2.3	550Ce2 Entertainment And Media Operation: Internet	24
4.2.4	550Ce2 Entertainment And Media Operation: Audio/Video	25
4.2.5	550Ce2 Entertainment And Media Operation: Virtual Scenery	26
4.2.6	550Ce2 Entertainment And Media Operation: YouTube	27
4.2.7	550Ce2 Entertainment And Media Operation: HDMI Input	28
4.3	550Ci Interactive Console Overview	29
4.4	How To Effectively Workout At Your Own Level	30
4.5	Central Control Center Overview	31
4.6	How To Personalize Your Workout	32

4.7	Save The Workout Profile.	33
4.8	How To Track Your Workout Record	34
4.9	Setting Of Intenza 550 Series Stairclimber	37
4.10	Begin The Workout	39
<b>5</b>	<b>WORKOUT OPTIONS</b>	40
5.1	Quick Start	41
5.2	Preset Program	42
5.3	Target Program	45
5.4	HRC Program	48
5.5	Custom Program	52
5.6	Race Program	55
5.7	Fitness Test	60
<b>6</b>	<b>MAINTENANCE</b>	65
6.1	Preventative Maintenance Tips	65
6.2	Self Diagnosis	66
<b>7</b>	<b>TROUBLE SHOOTING</b>	67
7.1	When To Call For Help	67
7.2	Error Message	68
7.3	How To Use The Safety Stop Pull Cord	68
<b>8</b>	<b>EXPLODED DRAWINGS, PARTS LIST AND SPECIFICATIONS</b>	69
8.1	Intenza 550Ce2 Stairclimber Exploded Drawing And Parts List	69
8.2	Intenza 550Ci Stairclimber Exploded Drawing And Parts List	72

## IMPORTANT SAFETY INSTRUCTIONS

---

When using an electrical appliance, basic precautions should always be followed, including the following:  
Read all instructions before operation

### **DANGER**

To reduce the risk of electric shock—

- Always unplug this appliance from the electrical outlet immediately after using and before cleaning.

### **WARNING**

To reduce the risk of burns, fire, electric shock, or injury to persons—

- The appliance should never be left unattended when plugged in. Unplug from outlet when not in use, and before putting on or removing parts.
- Do not operate the equipment under any kind of blanket or pillow: excessive heating can occur and cause fire, electric shock or injury to persons.
- Close supervision is necessary when this equipment is used by, on, or near children, invalids or disabled persons.
- Never operate this appliance if it has a damaged cord or plug, if it is not working properly, if it has been dropped, damaged or dropped into water. Please contact authorised dealer/distributor or service provider service center for examination and repair.
- Do not carry this appliance by its supply cord, or use the cord as a handle.
- Keep the replace appliance with equipment throughout cord away from heated surfaces.
- Never operate the equipment if air openings are blocked. Keep air openings free of dust, lint, hair and the like.
- Never drop or insert any object into any opening.
- Do not use the equipment outdoors.
- Do not operate the equipment where aerosol (spray) products are being used, or where oxygen is being administered.
- To disconnect the equipment, turn all controls to the “off” position, then remove plug from outlet.
- Below mentioned sound pressure level is measured under the condition when the trainer is operating with highest speed with no load. Sound pressure level (dB) < 70dB. Noise emission under load is higher than without load.

SAVE THESE INSTRUCTIONS

# WARNING

## GROUNDING INSTRUCTIONS

This product must be grounded. If it should malfunction or breakdown, grounding provides the path of least resistance for an electric current to reduce the risk of electric shock. This product is equipped with a cord containing a grounding conductor and plug. The plug must be plugged into an appropriate outlet that is properly installed and grounded in accordance with all local codes and ordinances.

Make sure the Intenza 550 Series Stairclimber is supported by the proper line voltage at the install location before plugging into the outlet. This equipment will be wired for either **120V AC** nominal power input or **220—240V AC** nominal input and is factory—equipped with the specific electric cord and plug to permit connection to the proper electric circuit. **Make sure that the equipment is connected to a dedicated circuit inserted in an outlet with the same configuration as that of the plug. If you are uncertain about the type of suitable power plug, please contact your distributor or a qualified local electrician. Do not use an adapter or extension cord with this equipment.**

### GROUNDING METHODS— AMERICA AND OTHER COUNTRIES USING 120 VOLTAGE

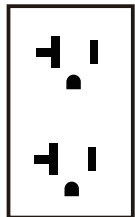

NEMA5—20R

### EUROPE AND OTHER COUNTRIES USING 220 VOLTAGE

Supply Voltage (VAC)	Frequency (Hz)	Current (Amps)	Power Consumption (W)
220—240	50/60	3.6	320

### AMERICA AND OTHER COUNTRIES USING 120 VOLTAGE

Supply Voltage (VAC)	Frequency (Hz)	Current (Amps)	Power Consumption (W)
120	50/60	4.1	290

# DANGER

Improper installation may result in a risk of electric shock. Check with a qualified electrician or serviceman if you are in doubt as to whether the product is properly grounded. Do not modify the plug provided with the product. If it does not fit the outlet, have a proper outlet installed by a qualified electrician.

## 2. Intenza 550 Series Stairclimber Overview And Assembly

---



## Important Safety Precautions

---

### **WARNING**

- Intenza 550 Series Stairclimber is designed for cardio vascular exercise in a commercial environment.
- Health—related injuries may result from incorrect or excessive use of exercise equipment. Please check with your physician prior to beginning any exercise program.
- Heart rate monitoring systems may be inaccurate. Over exercise may result in serious injury or death. If you feel faint, stop exercising immediately.

### **SAFETY PRECAUTIONS**

- Unsupervised children must be kept away from this equipment.
- Assemble and operate the equipment on a stable base and properly leveled.
- Keep an open area of 6.5 feet by 3 feet (2000 mm x 1000 mm) behind the Stairclimber for clear of any obstructions, including walls, furniture, and other equipment.
- Away from sources of heat, such as radiators, heat registers, and stoves. Avoid extreme temperature changes.
- Do not use outdoors or in an enclosed swimming pool environment.
- Keep equipment away from water and moisture. Avoid dropping anything on or spilling anything inside the equipment to prevent electric shock or damage the electronics.
- Never leave the equipment unattended when it is plugged in. Unplug the equipment from its power source when it is not in use for a long time.
- Do not drop or insert any object, hands, or feet into any opening, or underneath the equipment.
- Do not attempt to remove the cover or modify the equipment. Service should only be done by an authorized service technician.
- Do not use the equipment with bare feet. Wear shoes with rubber or high—traction soles. Do not use shoes with heels, leather soles, cleats, or spikes. Make sure no stones are embedded in the soles.
- Do not operate the equipment until the defective components are repaired.
- Use the handrails whenever additional stability is required. In case of emergency, such as tripping, the user should grab the handrails and place his/her feet on the side platforms. The handrails may be held to enhance stability as needed, but are not for continuous use.



## 2.1 550Ce2 Overview

---



## 2.2 550Ci Overview

---



### 2.3 550Ce2 & 550Ci Part List

Open the shipping carton. Remove all parts from the carton and card board inserts.

Before you begin the assembly, verify that the following hardware items are packed with the equipment. A 6 mm hex wrench is required to assemble the Stairclimber.

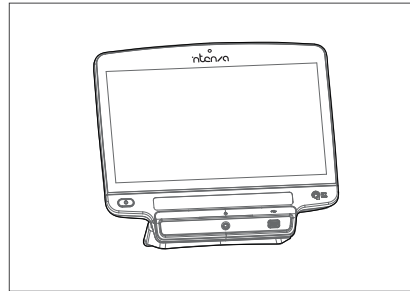

1. Entertainment console for 550 Ce2  
QTY 1

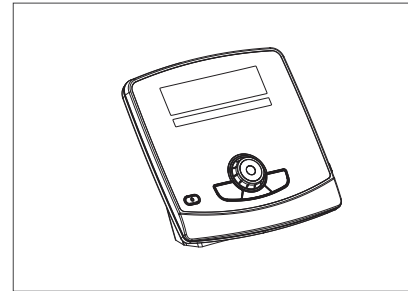

2. Interactive console for 550 Ci  
QTY 1

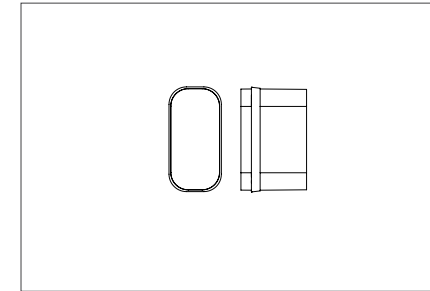

3. Cap, rubber, rear  
QTY 2

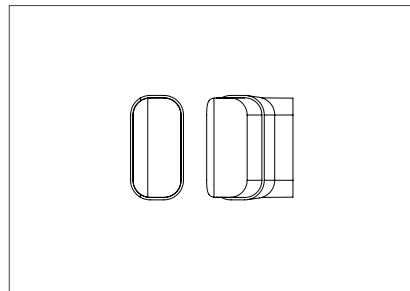

4. Cap, rubber, back  
QTY 2

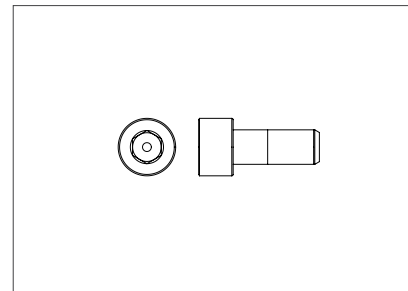

5. Screw, socket, M6 x 15L  
QTY 4

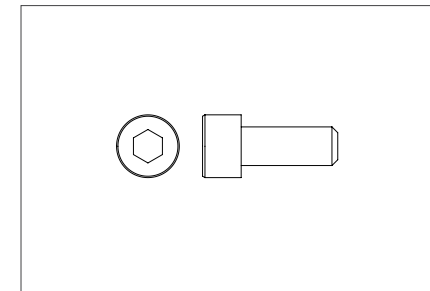

6. Screw, socket, M8 x 20L  
QTY 2

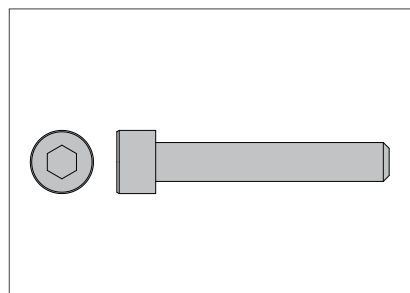

7. Screw, socket, M8x 40L,black  
QTY 4

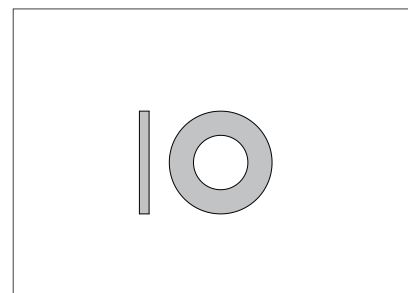

8. Flat washer, black  
QTY 2

## 2.4 550Ce2 & 550Ci Assembly Instructions

### STEP 1

Remove all parts from the carton and cardboard inserts.



### STEP 2

Lifting the console bridge up.

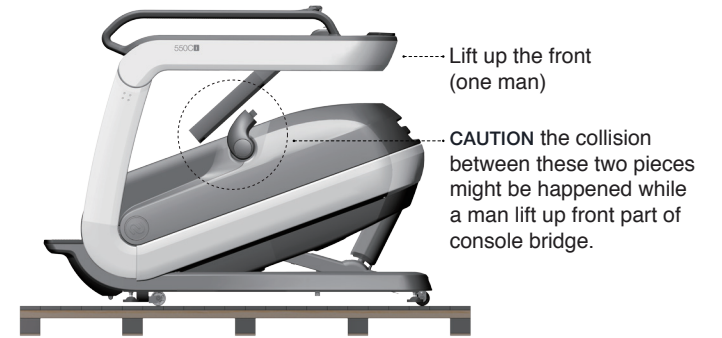

#### PLEASE NOTE

Three people are required to go through whole assembly process.

### STEP 3

Aligning the **right** and **left** upright posts in proper position.



#### PLEASE NOTE

Through the following assembly process, Manpower is required—two people.

### STEP 4

Installing the **right upright** post.



#### COMPONENTS AND TOOLS

Cap, rubber, rear(3), Cap, rubber back(4),

Screw, socket M6 x 15L (5), Hex wrench, 6mm

## 2.4 550Ce2 & 550Ci Assembly Instructions

### STEP 5

Installing the **left upright** post.

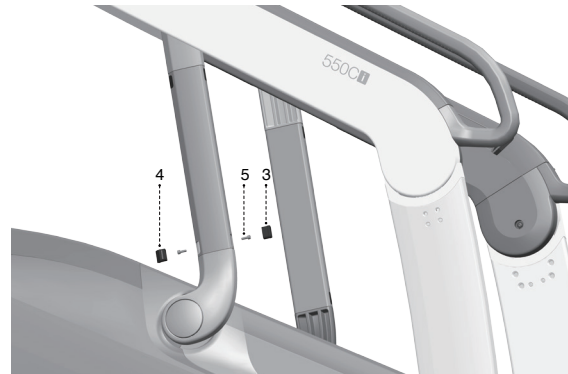

#### COMPONENTS AND TOOLS

Cap, rubber, rear(3), Cap, rubber back(4),  
Screw, socket M6 x 15L (5), Hex wrench, 6mm

### STEP 6—2

Installing the 550Ci Console—connect the cables.

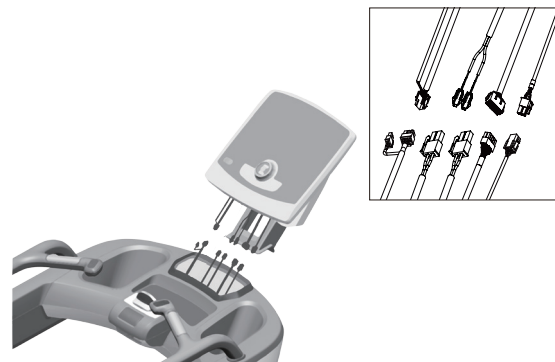

#### PLEASE NOTE

Ensure the 3 electrical connectors and 2 Heart Rate cable are well—connected between console and console bridge before moving to the next step.

### STEP 6—1

Installing the 550Ce2 Console—connect the cables.

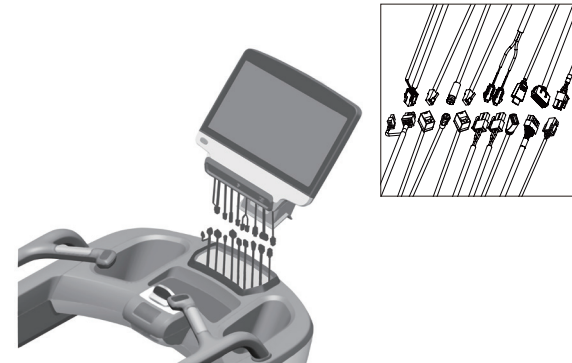

#### PLEASE NOTE

Ensure the 3 electrical connectors, ETHERNET cable, HDMI cable, CSAFE cable, 2 Heart Rate cable and TV cable are well—connected between console and console bridge before moving to the next step.

### STEP 7

Installing and securing the console—secure the console.

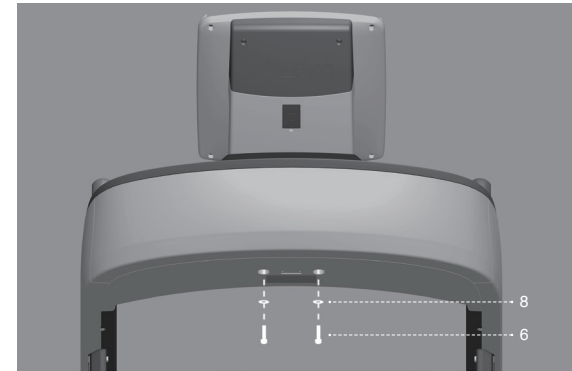

#### COMPONENTS AND TOOLS

Washer, flat(8), Screw, socket M8 x 20L(6),  
Hex wrench, 8mm

## 2.4 550Ce2 & 550Ci Assembly Instructions

### STEP 8

Moving 550Ce2/550Ci to the ground.

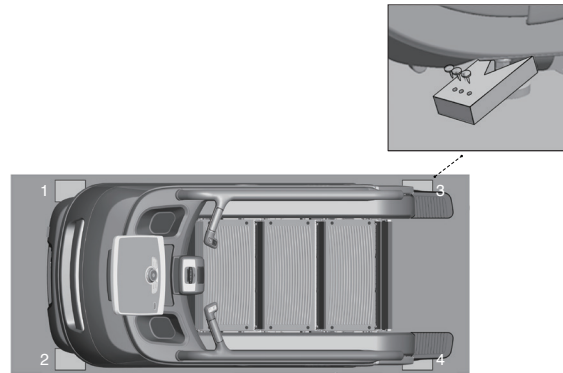

#### PLEASE NOTE

Release four nailed blocks which are installed on the cardboard.

### STEP 10

Placing inclined boards in proper position.

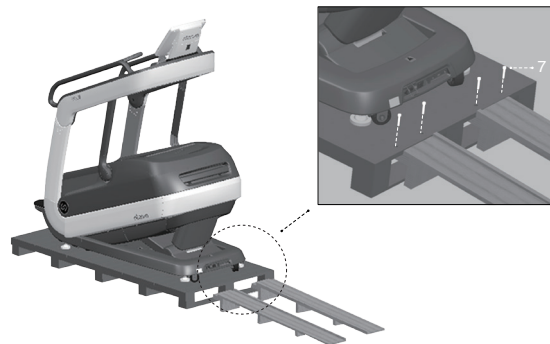

#### PLEASE NOTE

Two inclined boards are attached in outside cartons and inserted cardboards. Four screws are pinned through the cardboard and are used to locating the inclined boards

#### COMPONENTS AND TOOLS

Screw, socket M8 x 40L (7)

### STEP 9

Fastening up the screw of rubber feet in counter-clockwise direction.

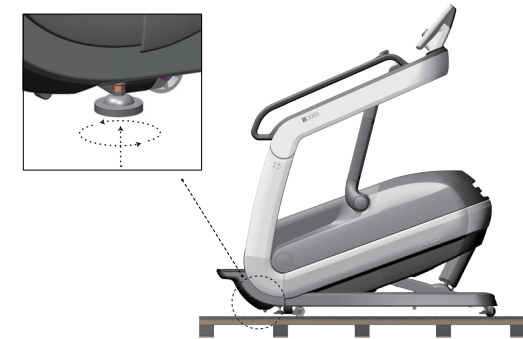

#### PLEASE NOTE

Fasten up four rubber feet away from the cardboard until the wheels attach to it.

#### COMPONENTS AND TOOLS

Open ended spanner, 19mm

### STEP 11

Slowly slipping on the two inclined boards.



### 3. Setup.

#### 3.1 Electrical Power Requirements

---

Below is the current rating for Intenza 550 Series Stairclimber based on supply voltage.

Make sure the Intenza 550 Series Stairclimber is supported by the proper line voltage at the install location before plugging into the outlet. This equipment will be wired for either **120 VAC** nominal power input or **220—240V AC** nominal input and is factory—equipped with the specific electric cord and plug to permit connection to the proper electric circuit.

Make sure that the Stairclimber is connected to a dedicated power line having an outlet with the same configuration as that of the plug.

**Do not use an adapter or extension cord with this equipment.**

##### EUROPE AND OTHER COUNTRIES USING 220 VOLTAGE

---

Supply Voltage (VAC)	Frequency (Hz)	Current (Amps)	Power Consumption (W)
220—240	50/60	3.6	320

---

##### AMERICA AND OTHER COUNTRIES USING 120 VOLTAGE

---

Supply Voltage (VAC)	Frequency (Hz)	Current (Amps)	Power Consumption (W)
120	50/60	4.1	290

---

### 3.2 Safety Space

Make sure that you maintain the proper safety space as shown below around the equipment.

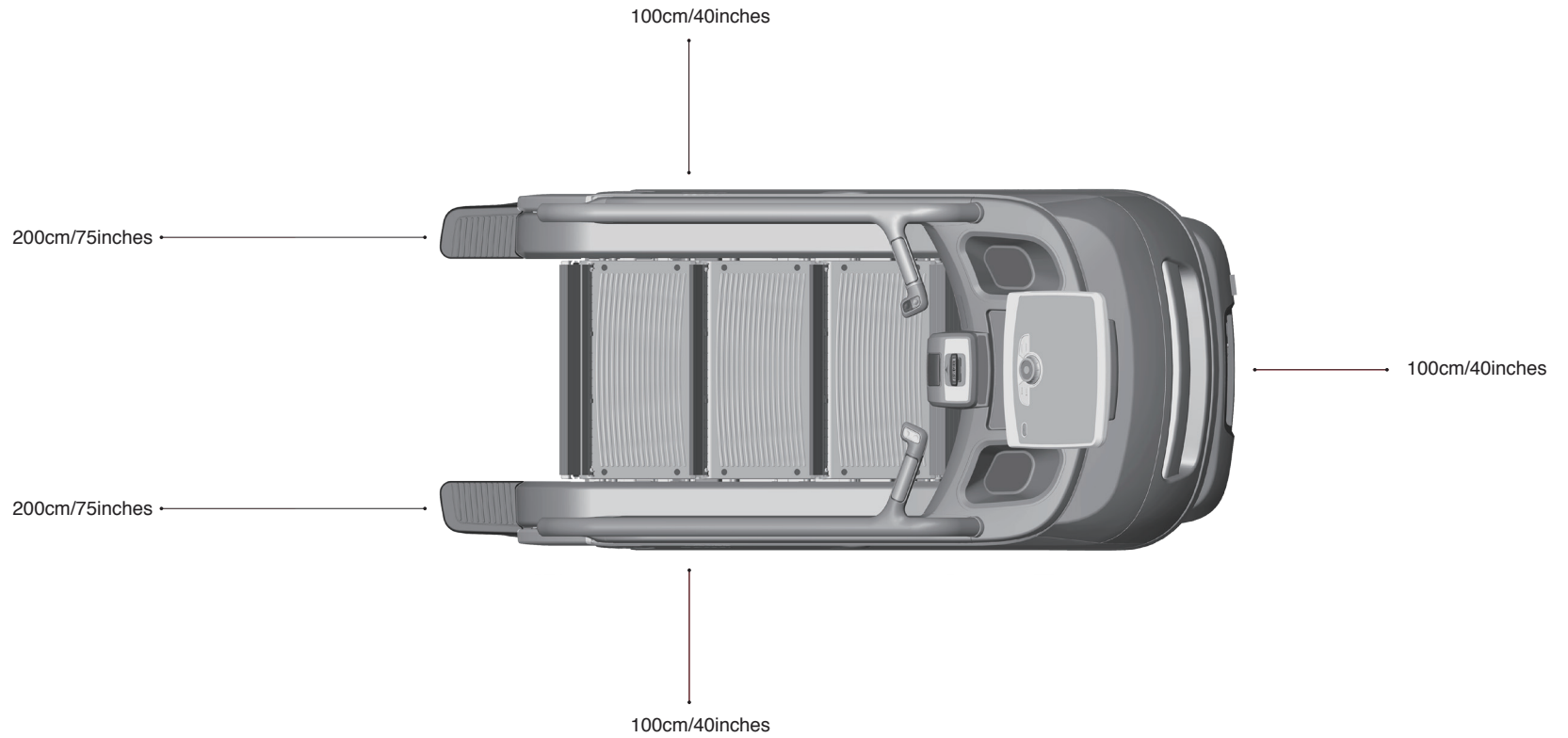



### 3.3 How To Stabilize The Intenza 550 Series Stairclimber

---

After putting the Stairclimber in place, check its stability.

If there is even a slight rocking motion or the unit is not stable, determine which stabilizing leg is not resting on the floor. To adjust, turn the stabilizing legs until the rocking motion stops and all stabilizing legs rest firmly on the floor. It is extremely important that the stabilizing leg be correctly adjusted for proper operation.



### 3.4 Power Switch

---

The power switch is located on the front panel at the base of Intenza 550 Series Stairclimber .

The ON/OFF switch has 2 positions: “ — ” represents ON and “ ○ ” represents OFF.













#### 4. How To Use Intenza 550 Series Stairclimber

---

**Operating the Intenza 550 Series Stairclimber is very easy.**

Operating Intenza 550 Series Stairclimber is very easy. Learning the features and incorporating Intenza 550 Series Stairclimber into your member's fitness program is just as easy. In this chapter, you will learn the display function and how to get the most workouts from Intenza 550 Series Stairclimber.

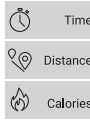
## 4.1 550Ce2 Entertainment Console Overview

Language		Arabic, Dutch, English (UK English), English (US English), Finnish, French, German, Hungarian, Japanese, Korean, Persian, Polish, Portuguese, Russian, Spanish, Simplified Chinese, Traditional Chinese, Turkish, Lithuanian, Italian 20 languages are offered.
		Language
Login		“Press” to login
Bluetooth		Displays Bluetooth connection status.
WiFi		Displays WiFi connection status.
USB		Displays USB connection status.
Swipe		Swipe screen horizontally to jump to next available screen.
Homepage Picture		Homepage picture changes depending on the machine.
Quick Start		Allows users to start a workout immediately, by passing any setup or goal setting.
Favorite Programs		Allows the user to easy access to frequently used programs.
Exercises		HR Control/Preset/Target (Time/Distance/Calories)/Custom/Race/Fitness Test. Allows users to select programs to setup “goal” or “customize” programs. Please refer to section 5 Workout Option.



### A ENERGY SAVER

The energy saver mode is used to minimize the power being used from the wall when Intenza 550Ce2 are not in use. Press this button to put Intenza 550Ce2 into energy saver mode after ending a workout. Press this button to either “wake up” Intenza 550Ce2.

### B READING AND TABLET RACK

Place traditional reading material, as well as mobile devices and tablets, in this built—in holder.

### C OPTIONAL RFID/NFC

Fitness facility owners can order this option for their users, allowing them to swipe facility identification card on the console.

### D HEADPHONE JACK

Allows you to plug in headphones.

### E USB PORT

Allows for data download. Read and play audio/video files.

### F HOME SCREEN

See home screen table to the left.

## 4.1 550Ce2 Entertainment Console Overview

---

Favorite



TV  
Phone  
Internet

Allows the user easy access to frequently used entertainments.

---

Entertainment

TV/Intenzacast/  
Internet/Video/Audio/Virtual  
scenery/YouTube/HDMI.

Entertainment >

During you workout, you can switch between different types of entertainment on the console.

## 4.2 550Ce2 Entertainment And Media Operation





---

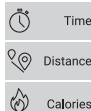

Users can select and set up entertainment items before entering a workout or quick start.

- TV: Watch live TV.
- Intenzacast: A wireless display standard designed for mirroring smart mobile devices to 550 E2 console.
- Internet: Users can quickly access pre-programmed websites and browse additional websites.
- Video/Audio: Watch or listen to a variety of videos or music audios (visible if USB device is detected).
- Reserved: Reserved function key (invisible now).
- Virtual scenery: A first-person, forward-motion video experience designed to enhance your workout.
- Youtube: Users can Browse and enjoy YouTube videos whilst working out.
- HDMI Input: Allows users to connect any digital audio and video source, such as a DVD player or set-top box. (visible if HDMI device is detected).

## 4.2.1 550Ce2 Entertainment And Media Operation: TV

Screen Size Toggle		During a workout session, press to toggle between standard and full screen sizes.
Exercise Program		Exercise programs are listed on the left column for quick access.
Channel Keypad	0 1	Users can input the TV channels with the screen keypad displayed.
Workout Status		Press to show your workout statistics or progress.
Channel List		List of all available channels.
Volume		Tap volume in the display and slide the volume bar up/down increase/decrease volume intensity.
Cool Down	COOL DOWN	Press during workout to begin a cool down period.
Stop	STOP	Press to stop the workout, then display workout summary and exit the workout program.
Pause	PAUSE	Press this key to pause the workout.
Back		Go back to Entertainment home screen.



Users can set up and watch TV before entering a workout—  
Select TV on the Entertainment screen.

## 4.2.2 550Ce2 Entertainment And Media Operation: Intenzacast







Intenzacast is a wireless technology that can be used to project your mobile device screen to 550Ce2 consoles.

Users can personalize their workout experience by connecting their smart mobile devices (Apple or Android) to Intenzacast via WiFi or RJ45 cable\*.

\*We highly recommend connecting 550Ce2 consoles with RJ45 cables to protect Intenzacast operating stability.

## 4.2.2 550Ce2 Entertainment And Media Operation: Intenzacast

### Intenzacast Steps—

Workout Status		Press to show your workout statistics or progress.	STEP 1	STEP 2	STEP 3	STEP 4	STEP 5
Volume		Tap volume in the display and slide the volume bar up/down increase/decrease volume intensity .	Select Intenzacast	Select operating system	Open Android cast screen Open iOS cast screen	Follow screen instructions (Android/iOS)	Project screen to 550Ce2 consoles
Quick Start		Allows the user to start a workout immediately, bypassing any setup or goal setting.	Detailed instructions for Intenzacast connection—				
Back		Go back to Entertainment home screen.	It is recommended to set up Intenzacast from the Start Up or Main Screen.				

### Detailed instructions for Intenzacast connection—

It is recommended to set up Intenzacast from the Start Up or Main Screen.

1. If in a program, enter **entertainment** and select Intenzacast.
2. Select operating system (Android/iOS).
  - 3.1 Open Android cast screen
    - Enable WiFi.
    - Swipe down with two fingers and you'll skip notifications and head straight into the full quick settings panel. Or double swipe down.
    - Choose Mirrorcast on your smart phone.

#### PLEASE NOTE

There are different names in different devices for Mirrorcast, ie Screen mirroring, Cast screen, HTC connect etc.

- 3.2 Open iOS cast screen:
  - Turn on WiFi of your **iOS** device. Your device will automatically search for available WiFi networks. Tap the name of Intenza to join. Please follow the instruction on e2 console display.
  - Swipe up from the bottom of your **iOS** device screen to access Control Center.
  - Tap AirPlay on your **iOS** device .
  - Tap the name of intenzacast and then turn on Mirroring.
4. Follow cast screen instructions to connect Intenzacast.
5. Project screen to 550Ce2 consoles.



## 4.2.3 550Ce2 Entertainment And Media Operation: Internet

Screen Size Toggle		During a workout session, press to toggle between standard and full screen sizes.
Exercise Program		Exercise programs are listed on the left column for quick access.
Workout Status		Press to show your workout statistics or progress.
Favorite Web List		List of saved websites (set up in Engineering mode only).
Volume		Tap volume in the display and slide the volume bar up/down to increase/decrease volume.
Cool Down	<b>COOL DOWN</b>	Press during workout to begin a cool down period.
Stop	<b>STOP</b>	Press to stop the workout, then display workout summary and exit the workout program.
Pause	<b>PAUSE</b>	Press this key to pause the workout.
Keyboard		Go back to Entertainment home screen.
Keyboard		Users can input the website address with the screen keypad displayed.







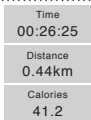

### Internet browsing at your fingertips—550Ce2 consoles.

Users can personalize their workout experience by connecting their smart mobile devices (Apple or Android) to Intenzacast via WiFi\*.

\*For internet access we highly recommend connecting 550Ce2 consoles with ETHERNET cables to protect Intenzacast operating stability.





## 4.2.4 550Ce2 Entertainment And Media Operation: Audio/Video

Screen Size Toggle		During a workout session, press to toggle between standard and full screen sizes.
Workout Status		Display your workout status whilst browsing websites.
Previous/Next		In “now playing” press Previous/Next to skip to the previous/next song or video in the list.
Workout Status		Press to show your workout statistics or progress.
Play List		Sort the music, songs or video content of USB by play list.
Volume		Tap on the Volume in the display and slide the volume bar up/down decrease/increase volume level.
Cool Down	<b>COOL DOWN</b>	Press during workout to begin a cool down period.
Stop	<b>STOP</b>	Press to stop the workout, then display workout summary and exit the workout program.
Pause	<b>PAUSE</b>	Press this key to pause the workout.
Back		Go back to Entertainment home screen or workout status dashboard.

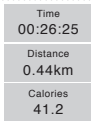

### Inserting a pre-loaded audio/video programmed USB

## 4.2.5 550Ce2 Entertainment And Media Operation: Virtual Scenery





Screen Size Toggle		During a workout session, press to toggle between standard and full screen sizes.
Workout Status		Display your workout status whilst browsing websites.
Swipe		Swipe screen horizontally to jump to next available screen.
Workout Status		Press to show your workout statistics or progress.
Virtual Scenery List		List of all virtual scenery videos. User can choose from available videos.
Cool Down	<b>COOL DOWN</b>	Press during workout to begin a cool down period.
Stop	<b>STOP</b>	Press to stop the workout, then display workout summary and exit the workout program.
Pause	<b>PAUSE</b>	Press this key to pause the workout.
Back		Go back to Entertainment home screen or workout status dashboard.



Virtual scenery is a first—person, forward—motion video experience designed to enhance users workouts.

Shot in beautiful locations, this feature turns indoor exercise into an outdoor adventure. Virtual scenery interacts with the equipment to provide an immersive experience. The framerate of the video is increased or decreased based on the speed of the connected exercise equipment.

## 4.2.6 550Ce2 Entertainment And Media Operation: YouTube\* \*\*

Screen Size Toggle		During a workout session, press to toggle between standard and full screen sizes.
Exercise Program		Press the left side button list can quick access to exercise programs.
Workout Status		Press to show your workout statistics or progress.
Volume		Tap on the Volume in the display and slide the volume bar up/down decrease/increase volume intensity..
Cool Down	<b>COOL DOWN</b>	Press during workout to begin a cool down period.
Stop	<b>STOP</b>	Press to stop the workout, then display workout summary and exit the workout program.
Pause	<b>PAUSE</b>	Press this key to pause the workout.
Back		Go back to Entertainment home screen.



Users can browse and enjoy YouTube videos while work out—

\*Similar operation for Youku(China).

\*\*Similar operation for Aparat(Iran).

**PLEASE NOTE** Features of HDMI Input are only applicable to consoles shipped with an integrated HDMI device.

#### 4.2.7 550Ce2 Entertainment And Media Operation: HDMI Input

---

HDMI technology is the global standard for connecting high—definition equipment.

HDMI Input is an alternative way to provide TV programs that use a HDMI single connect cable and signals as opposed to traditional coaxial cable and RF signals. It lets you connect any digital audio and video source, such as a DVD player or set—top box to 550Ce2 console.

## 4.3 550Ci Interactive Console Overview

- A** Profile Window  
This window displays the exercise profile for the selected workout.
- 
- B** Message Bar  
During the program set-up, operating instructions will be displayed in the message bar. During the workout, exercise data will be displayed below for your reference.  
**HR heart rate can be detected if the user is wearing the Polar heart rate chest strap or hold onto the contact heart rate grips consistently.**  
**Level** the level of the workout you are using, there are 40 levels.  
**TIME** the elapsed time since beginning the workout.  
**Incline Angle** the Incline angle of the stairclimber, the degree scale is from 20°(36.4%) to 40°(83.9%).  
**CALORIES** the number of calories burned since beginning the workout.  
**METs** the ratio of the work metabolic rate to the resting metabolic rate.  
**Floors** the number of floors user has climbed.  
**SPM Stairs Per Minute.**
- 
- C** Speed Scale  
SPM form the lowest 16 to highest 150 (You can adjust the highest SPM to 180 in engineering mode)
- 
- D** Back/ iSCAN  
**During program set up, press this key to go back to previous selection for correction.**  
**During the name setting, press this key to correct the wrong input.**  
**During the workout, the display information toggles between both exercises parameters in each message bar. Press SCAN to display one of the parameters statistic continuously throughout the workout.**
- ←** BACK  
**ⓘ** SCAN

- E** Energy Saver  
The energy saver mode is used to minimize the power being used from the wall when Intenza 550Ci is not in use. Press this button to put Intenza 550Ci into energy saver mode after ending a workout. Press this button to either “wake up” Intenza 550Ci.
- 
- F** USB Icon  
This icon lights up when Intenza console detects the USB device.
- 
- G** Programs  
Please refer to Section 5 Exercise Workout Option.
- 
- H** Quick Start/Enter  
**Press this key to enter the manual workout mode promptly, without selecting a workout program. The default speed is at 16**

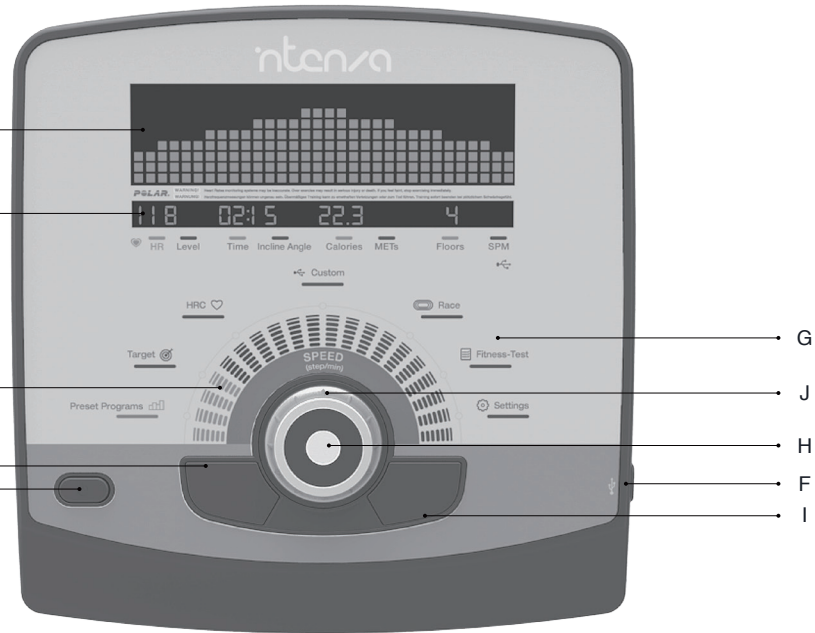

- ENTER** (Left Arrow) **SPM.mph)**  
**During program set up, press this key to confirm selection or value.**
- 
- I** Home/Stop Key  
**Press this key to go back to the first layer HOME when necessary.**
- 
- **STOP**  
**This key is only effective when a selected program is operating. Pressing STOP once will end the workout program and the message bar will show the workout summary. Pressing STOP again will exit the workout**
- 
- J** InZone™  
The skirting light of Uni—Dial™ indicates the workout intensity. (Please refer to Section 4.4 How To Effectively Workout At Your Own Level.)

**PLEASE NOTE** The heart rate function of Intenza 550 Series Stairclimber is intended only for use as an exercise aide. Various factors can affect the accuracy of your heart rate reading. The heart rate function of Intenza 550 Series Stairclimber should not be considered or used as a medical device.

## 4.4 How To Effectively Workout At Your Own Level

---

### **InZone™ system provides visual color feedback by skirting light.**

InZone™ system provides visual color feedback by illuminating the Skirting light of the Uni—Dial™. The different colors encourages users to optimize their workout efforts for maximum result based on heart rate level, and help users to stay in their target heart rate zones. InZone™ system will detects heart rate by 1) holding onto the contact heart rate plates or 2) by wearing a telemetry heart rate chest strap sensor. It is recommended to wear a telemetry heart rate chest strap for this function. During a workout there are 4 different colors that represent your workout intensity.

#### **GREEN: THE ENERGY EFFICIENT OR RECOVERY ZONE: 55% TO 65%**

---

Training within this zone develops basic endurance and aerobic capacity. All low intensity running should be completed at a maximum of 65%. Another advantage of exercising in this zone is that while you are happily burning fat you may lose weight and you will be allowing your muscles to re—energize with glycogen, which has been consumed during those faster pace workouts.

#### **YELLOW: THE AEROBIC ZONE: 65% TO 75%**

---

Training in this zone will improve your cardiovascular system. The body's ability to transport oxygen and carbon dioxide to and away from the working muscles can be developed and improved. As you become fitter and stronger from training in this zone, you may engage in some of your long weekend runs at up to 75% zone, the benefits of burning fat and improvement of aerobic capacity.

#### **ORANGE: THE ANAEROBIC ZONE: 75% TO 85%**

---

Training in this zone will develop your lactic acid system. In this zone, your individual anaerobic threshold (AT) is found—sometimes referred to the point of deflection (POD). This heart rates zone, the amount of fat being utilized as the main source of energy is greatly reduced and glycogen stored in the muscle is predominantly used. One of the by—products of burning this glycogen is lactic acid. The point at which the body can no longer quickly remove the lactic acid from the working muscles is your anaerobic threshold (AT). Through the correct training, it is possible to delay the AT by being able to increase your ability to deal with the lactic acid for a longer period of time or by improving your AT level.

#### **RED: THE EXTREME ZONE: 85% TO 100%**

---

Training in this zone will only be possible for a short period. It effectively trains your fast twitch muscle fibers and helps to develop speed. This zone is reserved for interval running and only the very fit are able to train effectively within this zone.

## 4.5 Central Control Center Overview

---

- A** Quick Start  
Initiate the motor to begin at 16 spm and 0% elevation in manual mode.
- 
- B** Incline Lever  
To adjust 550 Series Stairclimber incline, move the incline lever upward or downward.
- 
- C** Incline quick button to 20 degrees.
- 
- D** Incline quick button to 40 degrees.
- 
- E** Stop/Pause  
Press this key once to pause the workout. Press this key again to display workout information and exit the workout program. The pause time is set for 3 minutes. The display will count down from 3 minutes. When the **STOP** button is pressed, it will go to pause mode. If Intenza 550 Series Stairclimber is not resumed from "Pause", the Stairclimber will go back to Homepage.
- 
- F** Speed Control Button  
To adjust 550 Series Stairclimber SPM. Press the **+** key to increase 4 units of SPM, press the **-** key to decrease 10 units of SPM.

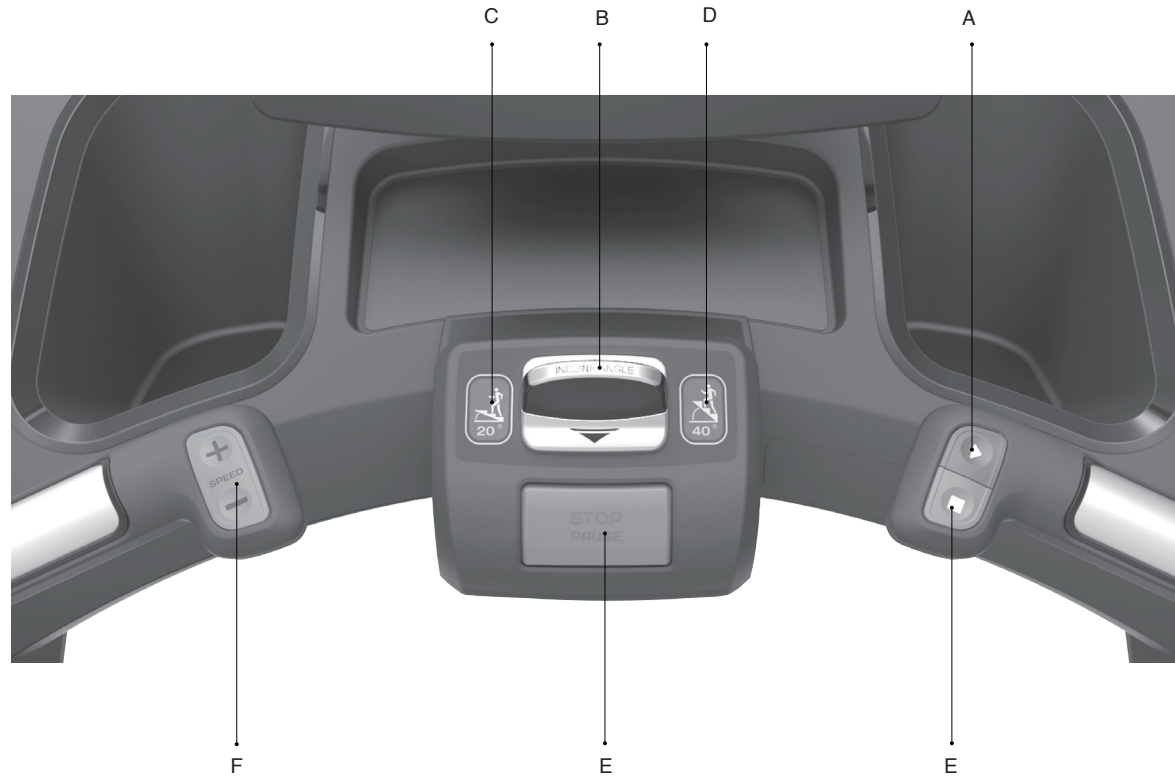



## 4.6 How To Personalize Your Workout

**PLEASE NOTE** The USB Screen Jump Button only appears if a USB device is plugged in and detected.

### For Ce2 & Ci, users can personalize the workout routine via USB.

The USB function also gives access to the service technician to download the usage record of Intenza 550 Series Stairclimber to track problem history and upgrade to a new version of software.

Workout Data: While you exercise, your Intenza 550 Series Stairclimber console will keep track of the following exercise parameters—

HR	LEVEL	TIME	INCLINE ANGLE
CALORIES	METS	FLOORS	SPM

These values will be recorded once every five seconds during the workout, if you have a installed a USB device before you began a workout program. Your downloaded data will be placed in a TREAD folder on your USB device as a .csv (Microsoft Excel compatible) format. You can open the file and review the data to track down your workout progress.

USB port is on the lower right side of the console. When a USB is plugged in, the USB icon will light up.

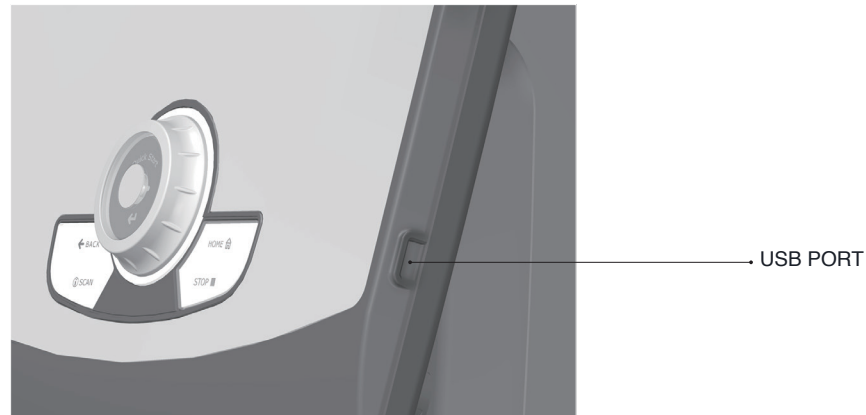

## 4.7 Save The Workout Profile.

### 4.7.1 Save The Workout Profile: 550Ce2

---

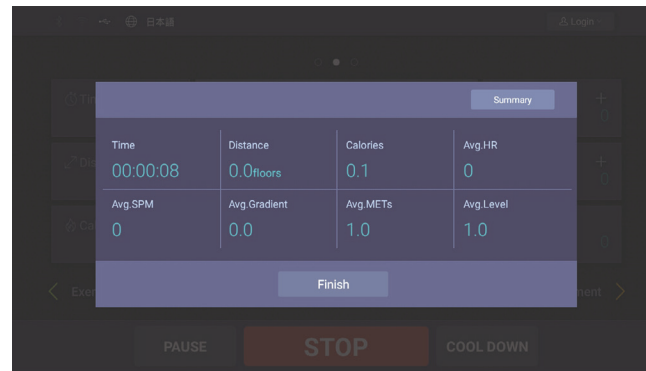

Insert the USB device to USB port, if you want to save the workout profile—

#### STEP 1

Press **STOP** to enter the workout summary mode and save the workout profile.

#### STEP 2

Choose **SAVE** to confirm saving.

#### STEP 3

Choose **FILE(SUNDAY—SATURDAY)** and press **YES** to confirm. When the display shows **SUCCESS** saving process is complete.

### 4.7.2 Save The Workout Profile: 550Ci

---

Insert the USB device to USB port, if you want to save the workout profile—

#### STEP 1

Press **STOP** or **ENTER** again to exit the workout summary mode and save the workout profile.

#### STEP 2

Choose **YES** to confirm saving or **NO** to exit by turning Uni—Dial™ and press **ENTER** to double confirm.

#### STEP 3

Choose **FILE (SUNDAY—SATURDAY)** by turning Uni—Dial™ and press **ENTER** to confirm. When the display shows **SAVING COMPLETE** saving process is complete.

## 4.8 How To Track Your Workout Record

---

You can easily personalize the workout routine and the workout data to manage your workout record.

For tracking the record easily, there are three folders—Custom, Fitness and Workout data. Each folder contains the record of the workout program.

### 4.8.1 Custom

---

This folder contains 7 files of the workout profile users save as DAYS.

- Information meaning
- The value A is the workout time.
  - The value B to AE is the workout SPM per minute.
  - The rest of values from AF is the incline % per minute.

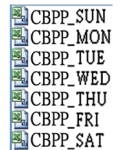

Route: CLIMBER\CUSTOM

---

	A	B	C	...	AE	AF	AG	...	BI
I	30	0	8	...	9	0	0	...	

---

Route: CLIMBER\CUSTOM\TDPP\_SUN

## 4.8.2 Workout

This folder contains file of workout data from all the programs of Intenza 550 Series Stairclimber.

The workout record will be saved automatically every 5 seconds.

Information meaning · Time: unit is 5 seconds.

- Calories: the accumulated calories burned during the workout.
- Floors: the accumulated floors during the workout.

The score record in the USB file needs to be multiplied by certain value in order to match the score displayed in the console. Incline, MET, and Speed data should be multiplied by 0.1. Distance data should be multiplied by 0.01.

Please refer to below example. Route: CLIMBER\WKODATA\CBWD0000.CSV

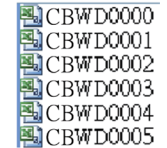

Route: CLIMBER\WKO\_DATA

	LEVEL	SPM	MET	INCLINE	HR	TIME	CALORIES	FLOORS
I	3	16	30	20	0	5	0	0
2	8	44	80	30	0	30	3	6
3	5	43	78	30	107	70	9	19
4	11	49	72	20	0	120	15	30

**MET data x 0.1**      **INCLINE data x 0.1= INC %**  
 21 x 0.1 = 2.1      50 x 0.1 = 5%

### 4.8.3 Fitness

---

This folder contains Fitness Test score record, including CBFIT.

The value is the score users attained by fitness test.

Information of CBFIT workout records

- File can be saved up to 30 score records, the most current record will be at the bottom.
- The score record in USB needs to be multiplied by 0.1 to match the score displayed in the console. Please refer to below example and Section 5.7 VO<sub>2</sub> MAX chart for more information.

A	
1	0
2	0
3	0
...	...
...	...
28	43
29	0
25	0
30	35

Route: CLIMBER\FITNESS\CBFIT.CSV

#### WFI

The WFI (Wellness Fitness Initiative) protocol is a test used by firefighters to evaluate aerobic fitness capacity as part of pre-employment testing and annual fitness testing. This assessment is a series of intervals lasting a maximum of 16 minutes, where the speed is increased every minute until the Target Heart Rate is exceeded for 15 seconds. When the test is complete, the display provides a summary of VO<sub>2</sub>max, Highest SPM, Elapsed Time and Target Heart Rate. This is a speed-dependent program.

#### CPAT

The Candidate Physical Ability Test (CPAT) is a new minimum requirement for the position of Firefighter. The job of a Firefighter is one of the most physically demanding jobs in North America. Participants wear a 50 pound (22.68 kg) vest to simulate the weight of self-contained breathing apparatus (SCBA) and firefighter protective clothing. An additional 25 pounds (11.34 kg), using two 12.5 pound (5.67 kg) weights that simulate a high-rise pack (hose bundle), is added to your shoulders for the stair climb event. The candidate must maintain 60 SPM (steps per minute) for 3 minutes.

## 4.9 Setting Of Intenza 550 Series Stairclimber

---

**PLEASE NOTE** The USB Screen Jump Button only appears if a USB device is plugged in and detected.

### The user can customize their personal settings by USB.

This friendly and convenient function is compatible with both series of Intenza products, e—series and i—series. You can enjoy your workout and enter the programs promptly without having to re—enter personal information (name, age, weight) setting. After using the Intenza 550Ce2 for a period of time, you may want to change some of the basic settings, e.g. distance unit or sound.

### 4.9.1 Intenza 550Ce2



---

#### Personalize and change the settings with USB device

STEP 1 .....>

Insert USB device to USB port

STEP 2 .....>

Press the  Login  on the screen.

STEP 3

Follow the onscreen instructions

**PLEASE NOTE** 550 series interactive console only support USB in FAT format. If your USB is in NTFS format, you need to reformat your USB to FAT format in order to be used in Intenza console.

## 4.9.2 Intenza 550Ci

---

### Personalize the setting with USB device

**STEP 1**

Insert USB device to USB port.

**STEP 2**

Select **UNIT** (Km/Mile) by turning Uni—Dial™ and press **ENTER**.

**STEP 3**

Input **AGE** by turning Uni—Dial™ and press **ENTER**.

**STEP 4**

Input **WEIGHT** by turning Uni—Dial™ and press **ENTER**.

**STEP 5**

Select the **SOUND** (On/Off) by turning Uni—Dial™ and press **ENTER**.

**STEP 6**

Edit the alphabet of **NAME** by turning Uni—Dial™ then press **ENTER** to confirm the alphabet. Then select **END** at the beginning to confirm the **NAME** editing.

**STEP 7**

During name editing, you can press **BACK** to edit correct the wrong input.

**STEP 8**

When you pause for 5 seconds or press **STOP**, **END** will show up. You can press **ENTER** to confirm and exit setting mode.

### Change the 550Ci setting

**STEP 1** .....▶

Choose **SETTING** by turning Uni—Dial™ and press **ENTER**.

**STEP 2** .....▶

Select **UNIT** (Km/Mile) by turning Uni—Dial™ and press **ENTER**.

**STEP 3** .....▶

Select **SOUND** (On/Off) by turning Uni—Dial™ and press **ENTER**.

**STEP 4**

Finally, you will see the display version and press **ENTER** to go back to home page.

## 4.10 Begin The Workout

**PLEASE NOTE** When any users slow down the speed and slide back closer to the sensor during workout, a reminder pops up on the console to remind users to continue to step up or to speed up.



### **PLEASE NOTE**

#### Side Stop/Pause Button

Press this button once to pause the workout. Press this key again to display workout information and exit the workout program. The pause time is set for 3 minutes. The display will count down from 3 minutes. When the **STOP** button is pressed, it will go to pause mode.

If Intenza 550 Series Stairclimber is not resumed from "Pause", the Stairclimber will go back to Homepage.



Before beginning any fitness program, see your physician for a complete physical examination.

To maintain your balance, always grasp a handlebar when you step on or off the foot pedals, or use the keypads.

### Training Starts—

1. Grasp the handlebars on both sides and step on the front pedal.
2. Step on the stairs.
3. Start to work out by pressing the button or controlling the console after grabbing the front handlebar and standing firm on the stairs.



### Training ends—

1. Stop the equipment by pressing STOP button.
2. Step backwards and ensure to grab handlebars on both sides.
3. Keep stepping backwards until safely land on the ground.





## 5. Workout Options

---

This section outlines Intenza 550 Series Stairclimber pre-programmed workouts.

This section outlines Intenza 550 Series Stairclimber pre-programmed workouts. The workout programs are easily accessed by turning the Uni-Dial™ dial switch and pressing ENTER to start the programs. By inserting a USB device before starting your workout, the Intenza console system can save your workout record automatically to the USB device every five seconds during your workout.

**PLEASE NOTE** To enter into this workout on Intenza 550Ce2 follow the onscreen prompt message.

## 5.1 Quick Start

---

### Quick Start allows users to begin a workout with one key press.

The default spm of Quick Start is at 16 with 20 degree. You can adjust the spm and the incline % during the workout. The workout record is saved automatically in every 5 seconds, when your personal USB device is installed prior to beginning your workout. When you complete the workout, workout profile is saved to your USB device as a routine workout by filename of days to track your exercise progress.

### To operate Quick Start program—

#### STEP 1

Step on Intenza Intenza 550 Series Stairclimber.

#### STEP 2

To save a workout record, insert a USB device to the USB port. Press **QUICK START** to enter the workout.

#### STEP 3

Proceed workout · 550Ce2 press **START** or **QUICK START** to run Stairclimber. The workout will automatically count.  
· 550Ci press **ENTER** or **QUICK START** to run Stairclimber. You don't need to enter workout time and timer will count up from 0:00.

#### STEP 4

During the workout, you can adjust the speed by using the shortcut on left handlebar. And pressing the **STICK SHIFT** forward to increase angle and pulling downward to decrease angle.

#### STEP 5

During the workout InZone™ will indicate your change of heart rate. (Please refer to Section 4.4 How To Effectively Workout At Your Own Level.)

#### STEP 6

During the workout, the workout data will be shown in the message bar under scan mode. Press **SCAN** to lock the workout data.

#### STEP 7

If you wish to **PAUSE** the workout · 550Ce2 press **PAUSE**  
· 550Ci press **STOP**

In pause mode, the countdown timer will show up for 3 minutes and the power will go off after 3 minutes.  
You can press **START** and run to restart the console.

#### STEP 8

For 550 Ce2, if you wish to cool down the workout, press **COOL DOWN**. The time will automatically count down from 4 minutes.  
You can adjust the cool down time by touch ▲▼ to extend and to shorten time.

#### STEP 9

Press **STOP** key or touch **STOP** on screen, if users wish to exit the program before you reach your workout goal,  
Press **STOP** again, or allow **PAUSE** or **COOL DOWN** timer to expire.

#### STEP 10

Save the workout profile. (Please refer to Section 4.7 Save The Workout Profile.)

**PLEASE NOTE** The workout time is set between 10 to 99 Minutes except 10 weeks Running(20—21min fixed).

## 5.2 Preset Program

Intenza 550 Series Stairclimber is designed with many preset programs to add variety and challenges to your workout plan.

Each program provides different benefits and can help you to achieve your own personal fitness goals.

### 5.2.1 Preset Program: Intenza 550Ce2

The Intenza 550Ce2 is designed with 20 preset programs.

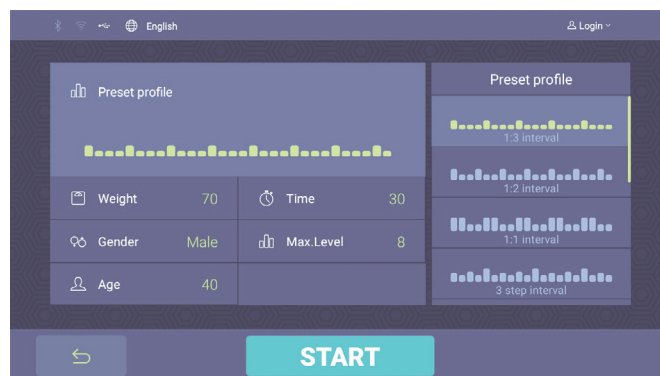

### Workout procedure

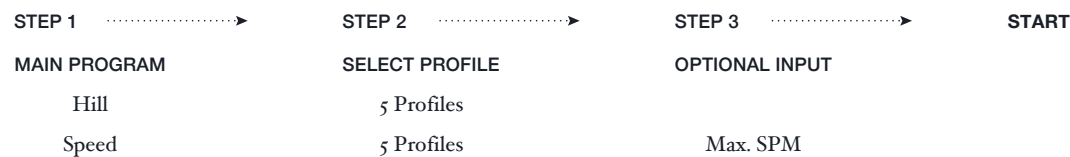

## 5.2.1 Preset Program: Intenza 550Ce2

---

### Detailed instructions for Intenza 550Ce2

#### STEP 1

Step on Intenza 550Ce2.

#### STEP 2

If you want to save your workout record, insert USB device to the USB port.

#### STEP 3

Select the profile you want to access and input the **WORKOUT TIME** you want by touching console screen.

#### STEP 4

Input **MAX SPM**, by touching console screen.

#### STEP 5

The timer will show up to count down for 3 seconds, then you will enter **WARM UP** timer, you can adjust the warm up time between 1—99 minutes, or touch **SKIP** to enter the workout.

#### STEP 6

If you wish to pause the program, press **STOP** or touch **PAUSE** on console screen. In pause mode, the countdown timer will show up for 3 minutes, and the power will go off after 3 minutes. You can adjust the pause time on your own. You can press **START** or touch **RESUME** on console screen and run to restart the console.

#### STEP 7

If you wish to cool down the workout, press **COOL DOWN**. The time will automatically count down from 4 minutes. You can adjust the cool down time by touch ▲▼ to extend and to shorten time.

#### STEP 8

Press **STOP** key, if you wish to exit the program before you reach your workout goal, press **STOP** again or allow pause timer to expire.

## 5.2.2 Preset Program: Intenza 550Ci

---

Intenza 550 Ci is designed with 10 preset programs.

### Workout procedure

STEP 1	STEP 2	STEP 3	START
MAIN PROGRAM	SELECT PROFILE	INPUT SPEED	
Hill	5 Profiles		
Speed	5 Profiles	Max. SPM	

### Detailed instructions for Intenza 550Ci

#### STEP 1

Step on Intenza 550Ci Stairclimber running platform.

#### STEP 2

If you want to save your workout record, insert USB device to the USB port. Choose **PRESET** by turning the Uni-Dial™ and press **ENTER** to confirm.

#### STEP 3

Choose **MODE ( HILL / SPEED )** by turning the Uni-Dial™ and press **ENTER**.

#### STEP 4

Select the desired profile and input the **WORKOUT TIME** you want by turning the Uni-Dial™ and press **ENTER** to confirm the setting.

#### STEP 5

Input **MAX SPM** by turning the Uni-Dial™ and press **ENTER** to confirm.

#### STEP 7

During the workout, the data will be shown in the message bar under scan mode. Press **SCAN** to lock the workout data.

#### STEP 8

If you wish to pause the program, press **STOP**. In pause mode, the countdown timer will show up for 3 minutes, and the power will go off after 3 minutes. You can press **START** and run to restart the console.

#### STEP 9

Press **STOP** key, if you wish to exit the program before you reach your workout goal, press **STOP** again or allow pause timer to expire.

#### PLEASE NOTE

**MAX SPM**—the peak of each column of workout profile. You need to input the **MAX SPM** for your own workout target according to your physical ability. You may also adjust the **SPM** and incline during the workout. To enter into this workout on 550Ce2, follow the onscreen prompt message.

**PLEASE NOTE** Users can set speed levels (1—25 km/h) (0.5—16 mph) before workout start at 550Ce2.

## 5.3 Target Program

The Intenza 550 Series Stairclimber offers 3 target workout options to meet your training goal.

By setting time, distance, or calories, you may choose the program by touching the console screen or turning the Uni-Dial™ dial switch to enter the program, If you want to save workout record, insert a USB device before beginning your workout.

### 5.3.1 Target Program: Intenza 550Ce2

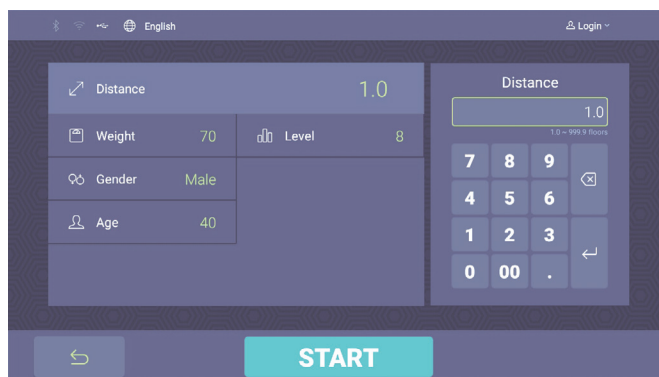

### Workout procedure

<b>STEP 1</b> →	<b>STEP 2</b> →	<b>START</b>
<b>PROGRAM</b>	<b>TARGET</b>	
Distance	Distance Setting: 1—999 floors	
Time	Time Setting: 10—99 minutes	
Calories	Calorie Setting: 10—9,999 kcal	

### 5.3.1 Target Program: Intenza 550Ce2

---

#### Detailed instruction for Intenza 550Ce2

##### STEP 1

Step on Intenza 550Ce2 running platform.

##### STEP 2

To save your workout record, insert a USB device to the USB port.

##### STEP 3

Choose **WORKOUT MODE (DISTANCE/TIME/CALORIES)** by touching the console screen to enter the target Program.

##### STEP 4

The distance range is from 1—999 Floors, the time range is from 10—99 minutes, and the calories range is from 10—9,999 kcal. Press **↵** to confirm.

##### STEP 5

The timer will show up to count down for 3 seconds, then you will enter **WARM UP** timer, you can adjust the warm up time between 1-99 minutes, or touch **SKIP** to enter the workout.

##### STEP 6

If you wish to **PAUSE** the program, press **STOP** or touch **PAUSE** on console screen.

In pause mode, the timer will show up and countdown for 3 minute, you can adjust the pause time by touching **▲▼** to extend and to shorten time. You can press **START** or touch **RESUME** on screen and run to restart the console.

##### STEP 7

If you wish to cool down the workout, press **COOL DOWN**. The time will automatically count down from 4 minutes. You can adjust the cool down time by touching **▲▼** to extend and to shorten time.

##### STEP 8

Press **STOP**, if you wish to exit the program before you reach your workout goal, press **STOP** again or allow pause timer to expire.

## 5.3.2 Target Program: Intenza 550Ci

---

### Workout procedure

STEP 1	STEP 2	START
<b>PROGRAM</b>	<b>TARGET</b>	
Distance	Distance setting: 1—999 Floors	
Time	Time setting: 10—99 minutes	
Calories	Calories setting: 10—2,500 kcal	

### Detailed instructions for Intenza 550Ci

#### STEP 1

Step on Intenza 550Ci.

#### STEP 2

To save your workout record, insert a USB device to the USB port. Choose **TARGET** program by turning the Uni-Dial™ and press **ENTER** to confirm.

#### STEP 3

Enter **AGE/GENDER/WEIGHT/DISTANCE/TIME/CAL** press **ENTER** to confirm.

#### STEP 4

Choose **MODE (DISTANCE/TIME/CALORIES)** by turning Uni-Dial™ and press **ENTER** to confirm.

#### STEP 5

The distance range is from 1—999 Floors, the time range is from 10—99 minutes, and the calories range is from 10—2,500 kcal. Press **ENTER** to confirm.

#### STEP 6

The timer will show up to count down for 3 seconds, then the workout will start automatically.

#### STEP 7

During workout **INZONE™** will indicate your change of heart rate. Please refer to Section 4.4 of How To Effectively Workout At Your Own Level.

#### STEP 8

During workout, the workout data will be shown in message bar under **SCAN** mode. Press **SCAN** to lock the workout data.

#### STEP 9

If you wish to **PAUSE** the program, press **STOP**. In pause mode, the timer will show up and countdown for 1 minute, the power will go off after 1 minute. You can press **START** and run to restart the console.



## 5.4 HRC Program

### The Intenza 550 Series Stairclimber offers 4 heart rate control workout options.

The heart rate control workout program allows the user to program their target heart rate zone. During the HRC program, the 550Ci LED will show the below profile which represents the target heart rate zone. Each column represents 1 minute of workout. The column that the user is currently using will flash for reference. You may just input the target workout heart rate % and your age, the Intelligent HR system will automatically calculate the personal target for you. The heart rate zone is calculated by using the following equation:  $(220 - \text{Age}) \times \% = \text{heart rate target zone}$ . The user must wear a telemetric heart rate chest strap for this workout.

#### HEART RATE ZONE

AGE	60%	65%	70%	75%	80%	85%
10	126	137	147	158	168	179
20	120	130	140	150	160	170
30	114	124	133	143	152	162
40	108	117	126	135	144	153
50	102	111	119	128	136	145
60	96	104	112	120	128	136
70	90	98	105	113	120	128
80	84	91	98	105	112	119
90	78	85	91	98	104	111
99	73	79	85	91	97	103

#### HEART RATE CONTROL PROGRAM OPTIONS

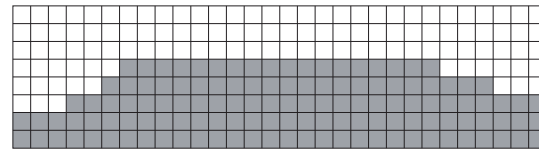

Constant HR

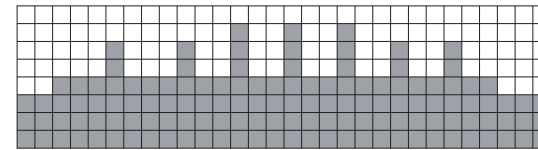

Interval HR

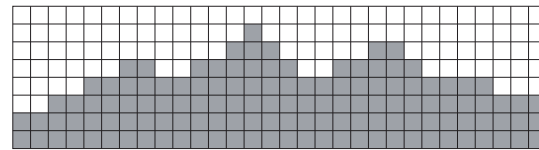

Hill HR

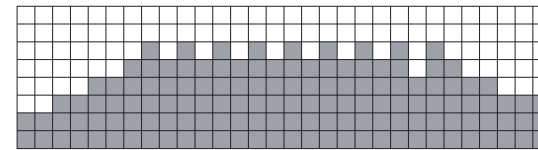

Cardio HR

## 5.4.1 Intenza 550Ce2

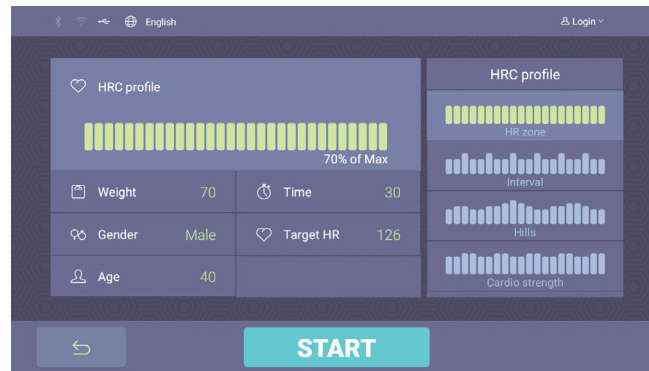

### Workout procedure

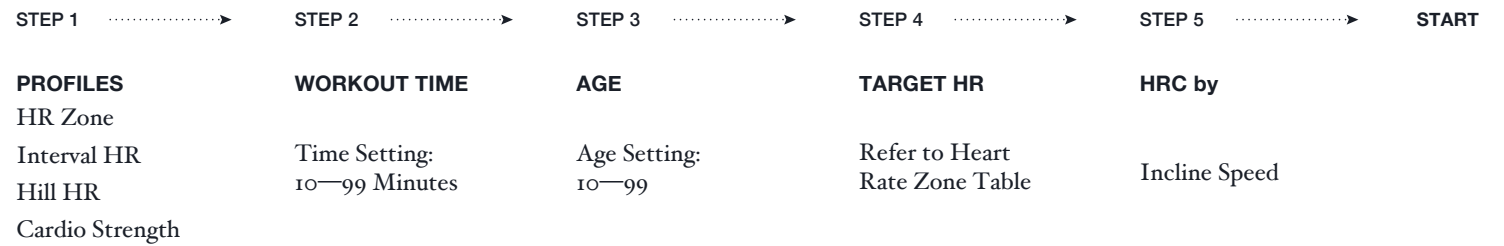

## 5.4.1 Intenza 550Ce2

---

### Detailed instruction for Intenza 550Ce2

#### STEP 1

Step on Intenza 550Ce2 running platform.

#### STEP 2

To save your workout record, insert a USB device to the USB port. Choose **HR Control** by touching console screen.

#### STEP 3

Choose **MODE (HR ZONE/INTERVAL /HILLS /CARDIO STRENGTH)** by touching console screen.

#### STEP 4

Input the **WORKOUT TIME** you want by touching console screen and press **↵** to confirm. You can choose the time from 10 to 99 minutes.

#### STEP 5

Input your **AGE** by touching console screen and press **↵**.

The default value of age is at 40 years old, while you can adjust the value from 10 to 99 years old.

#### STEP 6

Input **TARGET HEART RATE** by touching console screen and press **↵** to confirm.

#### STEP 7

Choose **HRC** mode by **INCLINE** or by **SPEED** by touching console screen and press **↵** to confirm.

#### STEP 8

The timer will show up to count down for 3 seconds, then you will enter **WARM UP** timer, you can adjust the warm up time between 1—99 minutes, or touch **SKIP** to enter the workout.

#### STEP 9

If you wish to **PAUSE** the program, press **STOP** or touch **PAUSE** on console screen. In pause mode, the timer will show up and countdown for 3 minute, you can adjust the pause time by touch **▲▼** to extend and to shorten time.

You can press **START** or touch **RESUME** on screen and run to restart the console.

#### STEP 10

Press **STOP**, if you wish to exit the program before you reach your workout goal, press **STOP** again or allow pause timer to expire.

## 5.4.2 Intenza 550Ci

**PLEASE NOTE** Calculating your theoretical maximum heart rate by using age is an approximation. For more information, please contact a fitness professional or physician.

You must wear telemetric heart rate chest strap for HRC program. Contact HR cannot be detected at HRC.

The default **TARGET HR** (Percentage of max HR) of each mode of heart rate control program is set for different training purpose.

### Workout procedure

STEP 1	STEP 2	STEP 3	STEP 4	STEP 5	START
<b>MODE</b>	<b>WORKOUT TIME</b>	<b>AGE</b>	<b>TARGET HR</b>	<b>HRC by</b>	
Constant HR					
Interval HR	Time Setting:	Age Setting:	Refer to		
Hill HR	10—99 Minutes	10—99	Heart Rate Zone	Incline SPM	
Cardio HR			Table		

### Detailed instruction for Intenza 550Ci

#### STEP 1

Step on Intenza 550 Ci.

#### STEP 2

To save your workout record, insert a USB device to the USB port Choose **HRC** by turning the Uni—Dial™ dial switch and press **ENTER** to confirm.

#### STEP 3

Choose **MODE** (CONSTANT HR/INTERVAL HR/HILL HR/CARDIO HR) by turning the Uni—Dial™ and press **ENTER** to confirm.

#### STEP 4

Input the **WORKOUT TIME** you want by turning the Uni—Dial™ and press **ENTER** to confirm. You can choose the time from 10 to 99 minutes.

#### STEP 5

Input your **AGE** by turning the Uni—Dial™ and press **ENTER**. The default value of age is at 30 years old. You can adjust the value from 10 to 99 years old.

#### STEP 6

Input **TARGET HEART RATE** by turning the Uni—Dial™ and press **ENTER** to confirm.

#### STEP 7

Choose **HRC** by **INCLINE** or by **SPEED** by turning the Uni—Dial™ and press **ENTER** to confirm.

#### STEP 8

The timer will show up to count down for 3 seconds then the workout will start automatically.

#### STEP 9

During the workout, the workout data will be shown in message bar under **SCAN** mode. Press **SCAN** to lock the workout data.

#### STEP 10

During workout **INZONE™** will indicate your change of heart rate. Please refer to section 4.4 How To Effectively Workout At Your Own Level.

#### STEP 11

If you wish to **PAUSE** the program, press **STOP**. In pause mode, the timer will show up and countdown for 3 minutes, the power will go off after 3 minutes. You can press **START** and run to restart the console.

#### STEP 12

Press **STOP**, if you wish to exit the program before you reach your workout goal, press **STOP** again or allow the pause timer to expire.

## 5.5 Custom Program

---

The Custom program allows a user to save personal workout data onto a USB.

You can customize the workout profile to meet your own workout goal. By using CUSTOM program, you may easily track exercise progress and choose the program you desire from the folders.

## 5.5.1 Intenza 550Ce2

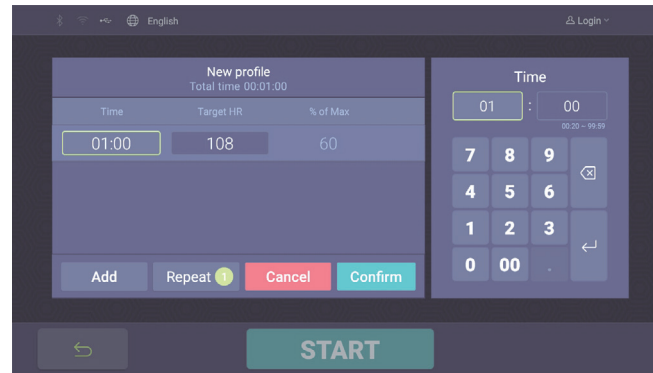

### Detailed instruction for Intenza 550Ce2

#### STEP 1

Step on Intenza 550Ce2.

#### STEP 2

Choose **CUSTOM** on 550Ce2 console.

#### STEP 3

Insert a USB device to USB port

#### STEP 4

If you want to create new profile, please follow below procedure

<b>A</b> .....>	<b>B</b> .....>	<b>C</b> .....>	<b>D</b> .....>	<b>START</b>
<b>CREATE NEW PROFILE</b>	<b>TIME</b>	<b>OPTIONAL INPUT</b>	<b>INCLINE</b>	
SPM	Time Setting 00:20—99:59	SPM setting	Incline Setting: 20—40	
FLOORS	Time Setting 00:20—99:59	Distance Setting	Incline Setting: 20—40	
HRC	Time Setting 00:20—99:59	Target HR Setting: 108—180	Incline Setting: 20—40	

#### STEP 5

You can choose **ADD** to create other new profiles.

#### STEP 6

You can choose **REPEAT** and **+** to create more than one identical profiles.

#### STEP 7

During the workout, you can adjust speed and incline %.

#### STEP 8

If you wish to **PAUSE** the program, press **STOP**. In pause mode, the timer will show up and countdown for 1 minute, the power will go off after 1 minutes. You can press **START** and run to restart the console.

#### STEP 9

Press **STOP**, if you wish to exit the program before you reach your workout goal, press **STOP** again or allow pause timer to expire.

#### STEP 10

If you want to keep the workout profile in the USB, choose **YES** to save the workout profile. Please refer to Section 4.7 Save The Workout Profile.

## 5.5.2 Intenza 550Ci

---

The custom program offers max 7 personal profiles save by default file name—

Monday, Tuesday, Wednesday, Thursday, Friday, Saturday and Sunday.

### Detailed instruction for Intenza 550Ci—

#### STEP 1

Step on Intenza 550Ci.

#### STEP 2

Insert a USB device to USB port otherwise custom program is unable to operate.

#### STEP 3

Choose **CUSTOM** by turning the Uni—Dial™ dial switch and press **ENTER** to confirm.

#### STEP 4

Choose **FILE NAME (SUNDAY—SATURDAY)** by turning the Uni—Dial™ and press **ENTER** to confirm.

#### STEP 5

During the workout, you can adjust speed and incline %. The workout data will be shown on message center under scan mode.

Press **SCAN** to lock the workout data.

#### STEP 6

During the workout InZone™ will indicate your heart rate level. Please refer to Section 4.4 How To Effectively Workout At Your Own Level.

#### STEP 7

To **PAUSE** the program, press **STOP**. In pause mode, the timer will show up and countdown for 1 minute, the power will go off after 1 minutes.

You can press **START** and run to restart the console.

#### STEP 8

Press **STOP**, if you wish to exit the program before you reach your workout goal, press **STOP** again or allow pause timer to expire.

#### STEP 9

If you want to keep the workout profile in the USB, choose **YES** to save the workout profile. Please refer to Section 4.7 Save The Workout Profile.

## 5.6 Race Program

---

The Race program offers a fun and challenging workout option.

You can compete against with previous champion which saved in the system or your previous record from a USB. If you win the record in the system (the default champion), your record and name can be saved to the console system for the next challenger. Also you can save your record to the USB. This race program is default at spm 16 with 0% incline, you can adjust the speed and incline during the workout.



## 5.6.1 Intenza 550Ce2

**PLEASE NOTE** Users can adjust **WARM UP** and **COOL DOWN** time (1—99 mins) by their own.

For 550Ce2, you can see your racing status on the dashboard.

The bright runner represents the user and the darker one represents your competitor. **BEHIND** is the distance between you and your competitor, **REMAIN** means the distance to your target.

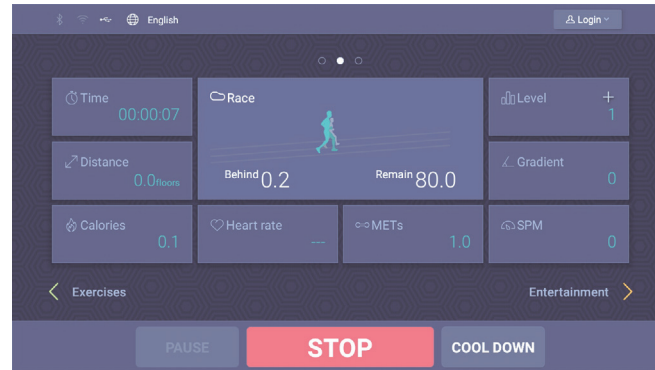

### Workout procedure

STEP 1	STEP 2	STEP 3	STEP 4	STEP 5	STEP 6	STEP 7
RACE TYPE	COMPETITOR	WARM UP	START	RACE	COOL DOWN	SAVE THE RECORD
20 Floors	Computer	Running 5 Minutes	Skip Warm Up	Duration	4 Minutes	Auto saving by USB
40 Floors	Computer/ Customize	Running 5 Minutes	Skip Warm Up	Duration	4 Minutes	Auto saving by USB/ Input Name To Console Memory
80 Floors	Customize	Running 5 Minutes	Skip Warm Up	Duration	4 Minutes	Input Name To Console Memory

## 5.6.1 Intenza 550Ce2

---

### Detailed instruction for Intenza 550Ce2

#### STEP 1

Step on Intenza 550Ce2.

#### STEP 2

Choose **RACE** by touching console screen.

#### STEP 3

Choose **MODE** (20Floors,40 Floors,80 Floors) by touching the console screen and press **↵** to confirm.

#### STEP 4

Select the competitor by touching console screen

**A** Computer (Intenza system default)—You can choose the records for **RACE MODE**. Ex.00/00:22:30/00:18:00 for 3KM/1.87miles.

**B** Custom—You can input customize record from 00:07:12 to 03:00:00.

#### STEP 5

Press **START** to start the workout, after you finish the **WARM UP**. You can adjust the pause time by touching **▲ ▼** to extend and to shorten time.

#### STEP 6

You will lose the race if you press **STOP**.

#### STEP 7

If you touch **COOL DOWN** mode for 4 minutes. You can adjust Cool down time (1—99 mins) by your own.

If you are no longer able keep up with the speed, press **STOP** to exit the workout.

#### STEP 8

Press **STOP** to exit the program before you reach your workout goal, press **STOP** again or allow pause timer to expire.

#### STEP 9

Racing result will be displayed in the profile window. You can save your name into Intenza console system when you win the last champion.

You can save the racing record under win or lose to your personal USB device.

## 5.6.2 Intenza 550Ci

---

For 550Ci, once you choose the race distance, the race tracks will be displayed in the profile window.

The outer lap represents the user and the inner lap represents your competitor. The laps will display the racing status by flashing LED light during your workout. A lap equals 400 meter, and the number shown next to the laps is the laps remaining.

### Workout procedure

STEP 1	STEP 2	STEP 3	STEP 4	STEP 5	STEP 6	STEP 7
RACE TYPE	COMPETITOR	WARM UP	START	RACE	COOL DOWN	SAVE THE RECORD
20 Floors	USB User	Running	Press Start	Duration	4 Minutes	Auto saving by USB
40 Floors	USB User/ Champion	Running	Press Start	Duration	4 Minutes	Auto saving by USB/ Input Name To Console Memory
80 Floors	Champion	Running	Press Start	Duration	4 Minutes	Input Name To Console Memory

## 5.6.2 Intenza 550Ci

---

### Detailed instruction for Intenza 550Ci

#### STEP 1

Step on Intenza 550Ci.

#### STEP 2

Choose **RACE** by turning the Uni—Dial™ dial switch and press **ENTER** to confirm.

#### STEP 3

Choose **MODE (20Floors,40 Floors,80 Floors )** by turning the Uni—Dial™ switch and press **ENTER** to confirm.

#### STEP 4

Select the competitor by turning the Uni—Dial™ switch.

**A** Champion from Intenza system— • Choose Champion to compete with by turning the Uni—Dial™ and press **ENTER** to start.

**B** Your previous record from USB— • Insert the USB device to USB port.  
• Choose USB to compete with by turning the Uni—Dial™ and press **ENTER** to start.

#### STEP 5

Press **ENTER** to start the workout, after you finish the **WARM UP**.

#### STEP 6

During the workout **INZONE™** will indicate your condition of heart rate. Please refer to Section 4.4 How To Effectively Workout At Your Own Level.

#### STEP 7

During the workout, the workout data will be shown in message bar under **SCAN** mode. Press **SCAN** to lock the workout data.

#### STEP 8

You will lose the race if you press **STOP**. When you win the race, Intenza 550Ci will enter **COOL DOWN** mode for 4 minutes.

#### STEP 9

Press **STOP** to exit the program before you reach your workout goal, press **STOP** again or allow pause timer to expire.

#### STEP 10

Racing result will be displayed in the profile window. You can save your name into the Intenza console system when you win the last champion. Also, you can save the racing record under win or lose to your personal USB device.

## 5.6.2 Intenza 550Ci

---

### Saving win record into Intenza system

#### STEP 1

Input your name in alphabet by turning the Uni—Dial™ and press **ENTER**.

#### STEP 2

During the name editing, you can press **BACK** to correct the wrong input.

#### STEP 3

When you complete your input, pause for 5 seconds or press **STOP** then **END** will show up. Press **ENTER** to confirm.

### Save racing win record into personal USB

#### STEP 1

Press **STOP** or **ENTER** to exit the summary mode.

#### STEP 2

Choose **YES** to confirm saving or **NO** to exit by turning the Uni—Dial™ and press **ENTER** to double confirm.

#### STEP 3

When the display shows **SAVING COMPLETED**, the process of saving is finished.

## 5.7 Fitness Test

---

### VO<sub>2</sub> max technology is useful in measuring the ability of an individual to transport and utilize oxygen during exercise progression.

It is beneficial to human for medical diagnosis, maximization of athletic performance, and determination of fitness performance in certain occupation, such as the U.S. Air Force, where specific standards must be met in order to remain employed. It is particularly useful in cardiology, sports medicine, and rehabilitative medicine.

The test starts at a low speed and gradually increases in speed levels. The test will end when the user presses **STOP**. Use of a telemetry heart rate strap is optional but can transmit more data to the system during the test. Once you finish the test and recovery period (cool down), the workout result and scores will be displayed in the profile window. Refer to **VO<sub>2</sub> MAX CHART** to interpret your test score.

## 5.7.1 Intenza 550Ce2

**PLEASE NOTE** Users can adjust Cool down time (1—99 mins) by their own.



### Workout procedure

STEP 1	STEP 2	STEP 3	STEP 4	STEP 5
TEST TYPE	AGE	GENDER	WORKOUT	COOL DOWN
WFI	Default Value: 40 Range: 10—99	Male	Duration	4 Minutes
CPAT		Female		

## 5.7.1 Intenza 550Ce2

---

### Detailed instructions for Intenza 550Ce2

#### STEP 1

Step on Intenza 550Ce2 running platform.

#### STEP 2

Choose **FITNESS TEST** by touching screen on console.

#### STEP 3

Choose Fitness Test **WALK** or **RUN** mode by touching screen on console.

#### STEP 4

When you are in **WALK** or **RUN** mode—

- Input your **AGE** by touching screen on console.
- Input your **GENDER** by touching screen on console..
- In the **WALKING** mode as a **MALE**, you must maintain the required speed from 5.3 km/h to 9.8 km/h while the required incline from 0% to 15%. In the **WALKING** mode as a **FEMALE**, you must maintain the required speed from 4.8 km/h to 7.2 km/h while the required incline from 0% to 15%. The workout time for **WALKING** mode is 30 minutes for both **MALE** and **FEMALE**.  
In the **RUNNING** mode, you must maintain the required speed from 2.7 km/h to 8.6 km/h while the required incline from 10% to 15%. The required speed and incline level are the same for both **MALE** and **FEMALE**. The workout time is 15 minutes.  
Please note during the fitness test, you can not adjust the speed and incline.
- Before Fitness Test workout start, you will enter **WARM UP** status, you can adjust the warm up time between 1—99 minutes, or touch **SKIP** to enter the workout.
- When you reach the target, Intenza 550Ce2 will enter **COOL DOWN** mode for 4 minutes. You can adjust Cool down time (1—99 mins) by your own. If you are no longer keep up with the speed, press **STOP** to exit the workout.
- The score will be shown on the console in either you finish the test or press **STOP** to leave the workout.
- The test result will be uploaded to USB for print out report. Route: \CLIMBER\FITNESS\TDFIT.

#### STEP 5

If your HR is over 100% maximum, the test program will stop automatically for your personal safety.

## 5.7.2 Intenza 550Ci

### Workout procedure

STEP 1	STEP 2	STEP 3	STEP 4	STEP 5
TEST TYPE	AGE	GENDER	WORKOUT	COOL DOWN
WFI	Default Value: 30 Range: 10—99	Male	Duration	4 Minutes
CPAT		Female		

### Detailed instruction for Intenza 550Ci

#### STEP 1

Step on Intenza 550Ci .

#### STEP 2

Choose **FITNESS TEST** by turning Uni—Dial™ dial switch and press **ENTER** to confirm.

#### STEP 3

Choose Fitness Test **WALK** or **RUN** mode by turning Uni—Dial™ dial switch and press **ENTER** to confirm.

#### STEP 4

When you are in **WALK** or **RUN** mode—

- Input your **AGE** by turning Uni—Dial™ switch and press **ENTER** to confirm.
- Input your **GENDER** by turning Uni—Dial™ switch and press **ENTER** to confirm.
- In the **WALKING** mode as a **MALE**, you must maintain the required speed from 5.3 km/h to 9.8 km/h while the required incline from 0% to 15%. In the **WALKING** mode as a **FEMALE**, you must maintain the required speed from 4.8 km/h to 7.2 km/h while the required incline from 0% to 15%. The workout time for **WALKING** mode is 30 minutes for both **MALE** and **FEMALE**.
- In the **RUNNING** mode, you must maintain the required speed from 2.7 km/h to 8.6 km/h while the required incline from 10% to 15%. The required speed and incline level are the same for both **MALE** and **FEMALE**. The workout time is 15 minutes.
- Please note during the fitness test, you can not adjust the speed and incline.
- Before Fitness Test workout start, you will enter **WARM UP** status, you can adjust the warm up time between 1-99 minutes, or touch **SKIP** to enter the workout.
- When you reach the target, Intenza 550Ci will enter **COOL DOWN** mode for 4 minutes. If you are no longer keep up with the speed, press **STOP** to exit the workout.
- The score will be shown on the console in either you finish the test or press **STOP** to leave the workout.
- The test result will be uploaded to USB for print out report. Route: \CLIMBER\FITNESS\TDFIT.

#### STEP 5

During the workout **INZONE™** will indicate your condition of heart rate.  
Please refer to Section 4.4 How To Effectively Workout At Your Own Level.

#### STEP 6

During the workout, the workout data will be shown on message center under **SCAN** mode. Press **SCAN** to lock the workout data.

#### STEP 7

If your HR is over 100% maximum, the test program will stop automatically for your personal safety.



## VO<sub>2</sub> Max Chart

Male (Values in ml/kg/min)

AGE	VERY POOR	POOR	FAIR	GOOD	EXCELLENT	SUPERIOR
13—19	<35.0	35.0—38.3	38.4—45.1	45.2—50.9	51.0—55.9	>55.9
20—29	<33.0	33.0—36.4	36.5—42.4	42.5—46.4	46.5—52.4	>52.4
30—39	<31.5	31.5—35.4	35.5—40.9	41.0—44.9	45.0—49.4	>49.4
40—49	<30.2	30.2—33.5	33.6—38.9	39.0—43.7	43.8—48.0	>48.0
50—59	<26.1	26.1—30.9	31.0—35.7	35.8—40.9	41.0—45.3	>45.3
60+	<20.5	20.5—26.0	26.1—32.2	32.3—36.4	36.5—44.2	>44.2

Female (Values in ml/kg/min)

AGE	VERY POOR	POOR	FAIR	GOOD	EXCELLENT	SUPERIOR
13—19	<25.0	25.0—30.9	31.0—34.9	35.0—38.9	39.0—41.9	>41.9
20—29	<23.6	23.6—28.9	29.0—32.9	33.0—36.9	37.0—41.0	>41.0
30—39	<22.8	22.8—26.9	27.0—31.4	31.5—35.6	35.7—40.0	>40.0
40—49	<21.0	21.0—24.4	24.5—28.9	29.0—32.8	32.9—36.9	>36.9
50—59	<20.2	20.2—22.7	22.8—26.9	27.0—31.4	31.5—35.7	>35.7
60+	<17.5	17.5—20.1	20.2—24.4	24.5—30.2	30.3—31.4	>31.4

## 6. Maintenance.

### 6.1 Preventative Maintenance Tips

With durable, high performance components, Intenza 550 Series Stairclimber is designed for heavy usage with minimal maintenance required.

To keep your Intenza 550 Series Stairclimber in safety level, Intenza strongly recommends performing the regular daily and regularly preventative maintenance routines outlined below.

#### DAILY MAINTENANCE

Locate the product in a dry, cool place.

Before and after each exercise session, ensure the area around Intenza 550 Series Stairclimber is free of obstacles and any clutter that may interfere with Intenza 550 Series Stairclimber operation.

Remove excessive accumulations of dust, dirt, and other substances by using a clean, soft cloth and a non—abrasive liquid cleaner.

Wipe down the exterior of the console, stick shift, handlebars, and contact heart rate grips.

Avoid getting extra moisture on the console. Keep the console free of fingerprints and sweat will extend the life of console.

Never use ammonia, acid—based, or petroleum—based solvents on any surface area of Intenza 550 Series Stairclimber as it may damage Intenza products.

#### REGULAR MAINTENANCE

Inspect the console mounting screws for security, and retighten if necessary.

Inspect the display panel keypads for wear.

Check the belt tension of drive belt.

Check operation of the emergency stop system.

Inspect and vacuum the area directly surrounding and under the unit regularly to keep debris from accumulating..

Check Intenza 550 Series Stairclimber is well—leveled. All of its feet should be leveled to the floor, and should not wobble when in use. If not, re—level the equipment.

## 6.2 Self Diagnosis

---

**Your Service Representative requires to check accumulated data about the past usage of Intenza 550 Series Stairclimber, test the function and error message.**

For these reasons, Intenza 550 Series Stairclimber is equipped with a service mode and can offer the diagnosis report for easy trouble shooting. Intenza 550Ce2 is designed with build-in WiFi that enhance InCare™ function. InCare™ function is a service diagnostic process that can automatically send out detected error message to Intenza customer service centre. Therefore, please make sure the Wi-Fi connection is well-connected after assembly. For more information of self diagnosis, please contact your local dealer or refer to the service manual.

**PLEASE NOTE** Replace defective components immediately or keep the equipment out of use until the equipment gets repaired.

## 7. Trouble Shooting.

### 7.1 When To Call For Help

---

#### **CHECKLIST**

- Verify the symptom and review the operating instructions.
- The problem may be unfamiliarity with the product, its features or the workout programs.
- Check the error message, then follow the instructions in the service manual.
- When the display shows **NEED MAINTENANCE**, you are suggested to contact with your local distributor for service.
- If the problem you encounter has not been solved by the above steps, and Intenza 550 Series Stairclimber is still not operational. Locate and document the serial number of the unit, and contact your local dealer.
- Send the diagnosis report (Please refer to Section 6.4 Self Diagnosis for more information.) and serial number to your local distributor for service.

#### **WHERE IS THE SERIAL NUMBER OF THE PRODUCT**

---

The serial number contains six digits, and there are two locations you can find Intenza 550 Series Stairclimber serial number—

- One is located on the front of Intenza 550 Series Stairclimber near the power switch.
- One is located on the mainframe that under the motor cover.

## 7.2 Error Message

When the display shows below message, below corrections for checking the problem and you can also refer to the service manual for more details.

MESSAGE	SOLUTION	550Ci	550Ce2
NEED MAINTENANCE	If error code is 1, 2, 4, 6, 7, 9, 20, 21, 50, 55, 102, 103, 104 console will display "Need Maintenance". Solution: Execute "Self Diagnosis" function to get error code for troubleshooting.	•	•
USB STICK FAIL	Cause: Bad connection between console and USB board or USB stick. · Re-plug in USB · Check cable connection between USB board and console or change cables if needed · Change USB board · Change console main board	•	•
CHECK SAFETY KEY (ERR8)	· Check safety key is properly inserted · Check safety key connection (cable and connector)	•	•
CHECK MEMORY (ERR 60) ; CHECK CONSOLE PCB (ERR 10) ; CHECK USB COMM (ERR 81) ;	· Reboot system and check if any error code remains · Change console main board	•	•
CHECK LCB or Cable (No error code and the reason of this message)	Check buzzer sound from LCB— · If the period of the sound is 3sec, check the cable connection from LCB to Console. · If the period of the sound is 1sec, change LCB.	•	•

## 7.3 How To Use The Safety Stop Pull Cord

When operating on the Stairclimber, please attach the Safety Stop clip to your T—shirt.

When operating on the Stairclimber, please attach the Safety Stop clip to your T—shirt. When the lanyard cord is pulled out from the Stairclimber, Intenza 550 Series Stairclimber will automatically slow down to stop. A message will be displayed on the console—"CHECK SAFETY KEY". In order to restart the Stairclimber, just re—attach the safety key to the slot.

## 8. Exploded Drawings, Parts List And Specifications.

### 8.1 Intenza 550Ce2 Stairclimber Exploded Drawing And Parts List

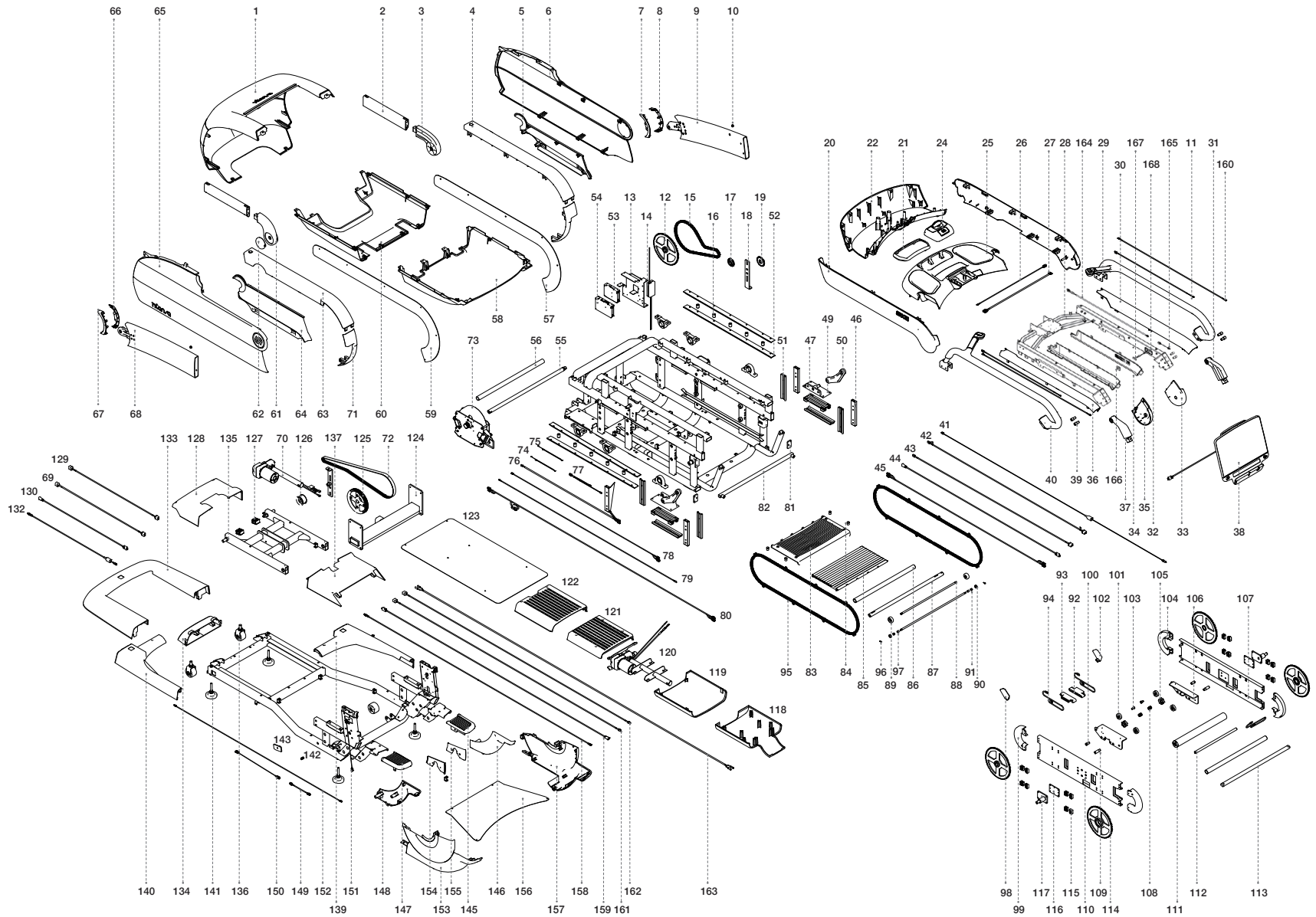

## 8.1 Intenza 550Ce2 Stairclimber Exploded Drawing And Parts List

NO	ITEM	NO	ITEM	NO	ITEM	NO	ITEM	NO	ITEM	NO	ITEM
1	Cover, front, w/ clip	31	Upright, post, front, R	61	Upright, post, front, L	91	Sleeve, wheel	121	Cover, incline, btm	151	Sensor, Emitter, RIKO PM6—2N
2	Upright, post, front	32	Cover, console, base, outside, R	62	Cover, pivot, lianarm	92	Bracket, support, pedal, R	122	Cover, incline, btm	152	Cable, IR
3	Upright, post, front, R	33	Cover, console, base, inside, R	63	Cover, frame, main, L	93	Bracket, support, pedal, L	123	Water—stop sheet	153	Cover, frame, base, outer, rear, L
4	Cover, frame, main, R	34	Cover, console, base, outside, L	64	Cover, frame, main, L	94	Elastic, rope	124	Frame, incline	154	Cover, upright post, btm, L
5	Cover, frame, main, R	35	Cover, console, base, inside, L	65	Cover, frame, main, L	95	O Chain	125	Pulley	155	Cover, upright post, btm, R
6	Cover, frame, main, R	36	Cover, console, base, LH	66	Upright, post outside, L	96	Pin, cotter	126	Idler	156	Cover, frame, base, btm
7	Upright, post outside, R	37	Upright, post, front, L	67	Upright, post inside, L	97	Sleeve, cover, pedal	127	Slider, track	157	Cover, frame, base, outer, rear, R
8	Upright, post inside, R	38	Console, 550Ce	68	Upright, post, rear, L	98	Side, cover, L	128	Cover, incline, front	158	Cable, TV
9	Upright, post, rear, R	39	Sleeve, handlebar, rear	69	Cable, C—safe, upright, post	99	Track, L	129	Cable, ethernet, upright, post	159	Cable, HDMI, frame, base
10	Sensor, cover	40	Handlebar, L	70	Motor, incline, DC24V	100	Sleeve, pedal	130	Cable, HDMI, upright, post	160	Cable, signal, handlebar
11	Cable, contact, pulse	41	Cable, TV	71	Cover, frame, main, L	101	Wheel, roller	131	Cable	161	Cable, frame, base, Ethernet
12	Sprocket	42	Cable, console, base, C—safe	72	Belt, drive	102	Side, cover, R	132	TV cable	162	Cable, frame, base, C—safe
13	Heatsink	43	Cable, console, base, ethernet	73	Hybrid generator, w/clutch	103	Shaft, wheel, pedal	133	Cover, frame, base, front	163	Cable, AC
14	Adaptor, 12V	44	Cable, HDMI, console, base	74	Cable, AC, 24V	104	Track, R	134	Cover, frame, base, front	164	Cable, signal, frame, base
15	O Chain	45	Cable, console, base	75	Cable, AC, 48V	105	Wheel, roller	135	Frame, incline	165	Cable, signal, frame, base
16	Sleeve, track	46	Bracket, support, track	76	Cable, hybrid	106	Bracket, pedal, R	136	Wheel, moving, front	166	key, safety
17	Sprocket	47	Guideway, linear, IGUS	77	Cable, AC, SMPS	107	Wheel, track, frame, R	137	Cover, incline, rear	167	Bracket, switch, safety
18	Bracket, sprockets, idler	48	Mounted, slide	78	Cable, DC, 24V	108	Spring	138	Frame, base	168	Switch, safety
19	Sprocket, idler	49	Bracket, support, track	79	Cable, sensor	109	Sleeve, pedal	139	Cover, frame, base, middle, R		
20	Cover, console, base, LH	50	Connect, frame	80	Cable, LCB, frame	110	Wheel, track, frame, L	140	Cover, frame, base, middle, L		
21	Console Bridge Neckless	51	Guideway, linear, IGUS	81	Bracket, adj, frame, main	111	Roller	141	Foot, support		
22	Cover, console base, btm	52	Bracket, track, top	82	Tube, frame, main, cross	112	Tube, pedal	142	Spring		
23	Cover, console, base, RH	53	100W Output Switch Power Supply	83	Pedal	113	Shaft, sprocket	143	Adjust, frame, base		
24	Keypad	54	150W Output Switch Power Supply	84	Cap, pedal	114	Sprocket, rear	144	Wheel, moving, incline		
25	Cover, console base, top	55	Shaft, pulley, step—up	85	Cover, padal	115	Carriag, slide	145	Pedal, PU, R		
26	Cable, contact, pulse	56	Sleeve, Shaft, sprocket	86	Sleeve, Shaft, sprocket	116	Bracket, track	146	Cover, frame, base, inner, R		
27	Cable, single, handlebar	57	Cover, frame, main, R	87	Shaft, sprocket	117	Support, frame, track	147	Pedal, PU, L		
28	Console, base	58	Cover, frame, main, rear	88	Shaft, roller	118	Cover, incline, top	148	Cover, frame, base, inner, L		
29	Handlebar, R	59	Cover, frame, main, inside, L	89	Wheel w/bearing, POM	119	Cover, incline, top	149	Cable, IR		
30	Cover, console, base, R	60	Cover, frame, main, rear	90	Bearing, ball, 608ZZ	120	Motor, incline, DC24V	150	Sensor, Receiver, RIKO PM6—2N		

## 8.1 Intenza 550Ce2 Stairclimber Exploded Drawing And Parts List

### Specifications: Intenza 550Ce2 Stairclimber

Design Use	Commercial
Maximum User Weight	181kgs/400 lbs
Speed levels	40
Adjustable slope	20—40

#### CONSOLE

Type	19" TFT—LCD resistive touch panel monitor
Display	Heart rate, Level, Time, Incline Angle, Calories, METs, Floors, SPM
Language	20 countries
Broadcast capabilities	Analog & Digital support ATSC, DVB—T/T2/C/S, ISDB (For details support on Digital TV, contact your Intenza Sales Representative)
Summaries	Total elapsed time of workout, total calories burned, total distance, total METs generated, heart rate profile record
Workout	Quick start, Preset programs, Target programs, Heart rate programs, Custom programs, Race programs, Fitness test
Heart rate monitor	Polar telemetry heart rate monitoring system
Step—up height	12.2" (31cm)
Step height	4—7.7" (10.4—19.6cm)
Step depth	10.2" (26cm)
Step width	21.2" (54cm)

ASSEMBLY DIMENSIONS		
DIMENSION	550Ce2	
LENGTH	1,930 mm	76 inches
WIDTH	860 mm	33.8 inches
HEIGHT (20 DEGREE)	2,130 mm	83.8 inches
HEIGHT (40 DEGREE)	2,330 mm	91.7 inches
WEIGHT	335 kgs	739 lbs

SHIPPING DIMENSIONS		
DIMENSION	550Ce2	
LENGTH	2,200 mm	86.6 inches
WIDTH	965 mm	37.9 inches
HEIGHT	1635 mm	64.3 inches
WEIGHT	431 kgs	950 lbs

### The testing parameters for class A

Training speed set 53 SPM.

Inclination set 20, 40 degrees.



## 8.2 Intenza 550Ci Stairclimber Exploded Drawing And Parts List

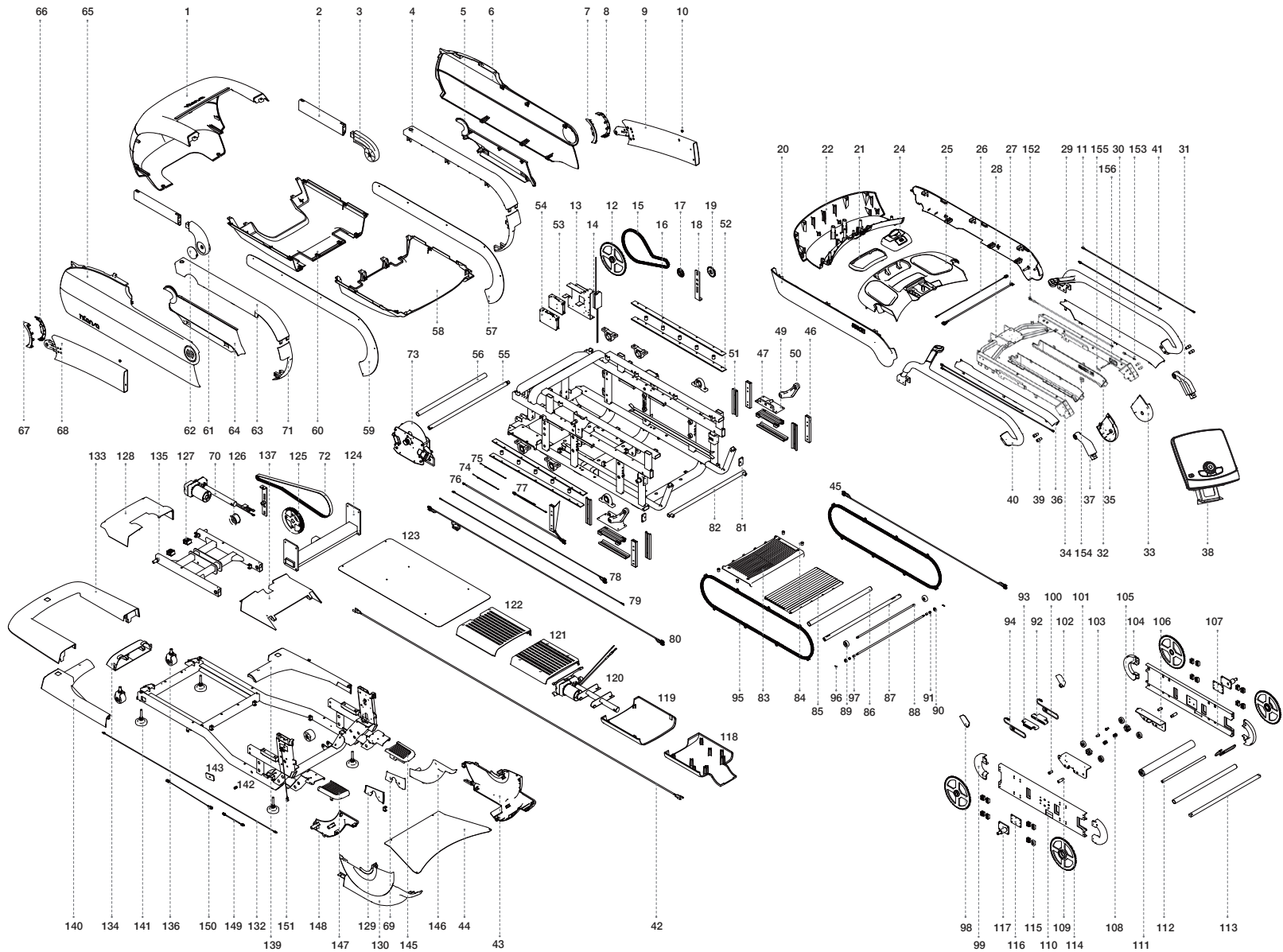

## 8.2 Intenza 550Ci Stairclimber Exploded Drawing And Parts List

NO	ITEM	NO	ITEM	NO	ITEM	NO	ITEM	NO	ITEM	NO	ITEM
1	CoveCover, front, w/ clip	31	Upright, post, front, R	61	Upright, post, front, L	91	Sleeve, wheel	121	CCover, incline, btm	151	Sensor, Emitter, RIKO PM6—2N
2	Upright, post, front	32	Cover, console, base, outside, R	62	Cover, pivot, lianarm	92	Bracket, support, pedal, R	122	Cover, incline, btm	152	Cable, signal, frame, bace
3	Upright, post, front, R	33	Cover, console, base, inside, R	63	Cover, frame, main, L	93	Bracket, support, pedal, L	123	Water—stop sheet	153	Cable, signal, frame, base
4	Cover, frame, main, R	34	Cover, console, base, outside, L	64	Cover, frame, main, L	94	Elastic, rope	124	Frame, incline	154	key, safety
5	Cover, frame, main, R	35	Cover, console, base, inside, L	65	Cover, frame, main, L	95	O Chain	125	Pulley	155	Bracket, switch, safety
6	Cover, frame, main, R	36	Cover, console, base, LH	66	Upright, post outside, L	96	Pin, cotter	126	Idler	156	Switch, safety
7	Upright, post outside, R	37	Upright, post, front, L	67	Upright, post inside, L	97	Sleeve, cover, pedal	127	Slider, track		
8	Upright, post inside, R	38	Console, 550Ci	68	Upright ,post, rear, L	98	Side, cover, L	128	Cover, incline, front		
9	Upright ,post, rear, R	39	Sleeve, handlebar, rear	69	Cover, upright post, btm, R	99	Track, L	129	Cover, upright post, btm, L		
10	Sensor, cover	40	Handlebar, L	70	Motor, incline, DC24V	100	Sleeve, pedal	130	Cover, frame, base, outer, rear, L		
11	Cable, signal, handlebar	41	Cable, contact, pulse	71	Cover, frame, main, L	101	Wheel, roller	131	Cable		
12	Sprocket	42	Cable, AC	72	Belt, drive	102	Side, cover, R	132	Cable, IR		
13	Heatsink	43	Cover, frame, base, outer, rear, R	73	Hybrid generator, w/clutch	103	Shaft, wheel, pedal	133	Cover, frame, base, front		
14	Adaptor, 12V	44	Cover, frame, base, btm	74	Cable, AC, 24V	104	Track, R	134	Cover, frame, base, front		
15	O Chain	45	Cable, console, base	75	Cable, AC, 48V	105	Wheel, roller	135	Frame, incline		
16	Sleeve, track	46	Bracket, support, track	76	Cable, hybrid	106	Bracket, pedal, R	136	Wheel, moving, front		
17	Sprocket	47	Guideway, linear, IGUS	77	Cable, AC, SMPS	107	Wheel, track, frame, R	137	Cover, incline, rear		
18	Bracket, sprockets, idler	48	Mounted, slide	78	Cable, DC, 24V	108	Spring	138	Frame, base		
19	Sprocket, idler	49	Bracket, support, track	79	Cable, sensor	109	Sleeve, pedal	139	Cover, frame, base, middle, R		
20	Cover, console, base, LH	50	Connect, frame	80	Cable, LCB, frame	110	Wheel, track, frame, L	140	Cover, frame, base, middle, L		
21	Console Bridge Neckless	51	Guideway, linear, IGUS	81	Bracket, adj, frame, main	111	Roller	141	Foot, support		
22	Cover, console base, btm	52	Bracket, track, top	82	Tube, frame, main, cross	112	Tube, pedal	142	Spring		
23	Cover, console, base, RH	53	100W Output Switch Power Supply	83	Pedal	113	Shaft, sprocket	143	Adjust, frame, base		
24	Keypad	54	150W Output Switch Power Supply	84	Cap, pedal	114	Sprocket, rear	144	Wheel, moving, incline		
25	Cover, console base, top	55	Shaft, pulley, step—up	85	Cover, padal	115	Carriag, slide	145	Pedal, PU, R		
26	Cable, contact, pulse	56	Sleeve, Shaft, sprocket	86	Sleeve, Shaft, sprocket	116	Bracket, track	146	Cover, frame, base, inner, R		
27	Cable, single, handlebar	57	Cover, frame, main, R	87	Shaft, sprocket	117	Support, frame, track	147	Pedal, PU, L		
28	Console, base	58	Cover, frame, main, rear	88	Shaft, roller	118	Cover, incline, top	148	Cover, frame, base, inner, L		
29	Handlebar, R	59	Cover, frame, main, inside, L	89	Wheel w/bearing, POM	119	Cover, incline, top	149	Cable, IR		
30	Cover, console, base, R	60	Cover, frame, main, rear	90	Bearing, ball, 608ZZ	120	Motor, incline, DC24V	150	Sensor, Receiver, RIKO PM6—2N		

## 8.2 Intenza 550Ci Stairclimber Exploded Drawing And Parts List

### Specifications: Intenza 550Ci Stairclimber

Design Use	Commercial
Maximum User Weight	181kgs/400 lbs
Speed levels	40
Adjustable slope	20—40

#### CONSOLE

Type	LED display
Display	Heart rate, Level, Time, Incline Angle, Calories, METs, Floors, SPM
Summaries	Total elapsed time of workout, total calories burned, total distance, total METs generated, heart rate profile record
Workout	Quick start, Preset programs, Target programs, Heart rate programs, Custom programs, Race programs, Fitness test
Heart rate monitor	Polar telemetry heart rate monitoring system
Step—up height	12.2" (31cm)
Step height	4—7.7" (10.4—19.6cm)
Step depth	10.2" (26cm)
Step width	21.2" (54cm)

ASSEMBLY DIMENSIONS		
DIMENSION	550Ci	
LENGTH	1,930 mm	76 inches
WIDTH	860 mm	33.8 inches
HEIGHT (20 DEGREE)	2,130 mm	83.8 inches
HEIGHT (40 DEGREE)	2,330 mm	91.7 inches
WEIGHT	331 kgs	729 lbs

SHIPPING DIMENSIONS		
DIMENSION	550Ci	
LENGTH	2,200 mm	86.6 inches
WIDTH	965 mm	37.9 inches
HEIGHT	1635 mm	64.3 inches
WEIGHT	427 kgs	940 lbs

#### The testing parameters for class A

Training speed set 53 SPM.

Inclination set 20, 40 degrees.

© 2019 HealthStream Taiwan Inc.  
No.28, Jiaotuzai Blvd., Liuying Dist., Tainan City 736, Taiwan  
intenzafitness.com  
Printed in Taiwan  
Version—1.2.2



DESIGNED, ENGINEERED AND BUILT IN TAIWAN  
[intenzafitness.com](http://intenzafitness.com)

